



TAKACHI ELECTRONICS ENCLOSURE CO., LTD.

3-21-16 Higashi-ryoke, Kawaguchi-shi, Saitama, 332-0003 JAPAN

Tel. +81-48-222-5409 / Fax. +81-48-222-7652

Aug 18, 2023

## NOTICE

### V series - Changes to O-ring shape and material

- **Changes** : O-ring shape and material.
- **Affected models** : V60, V80, V60S, V80S
- **Details**

#### Current (old) O-ring:

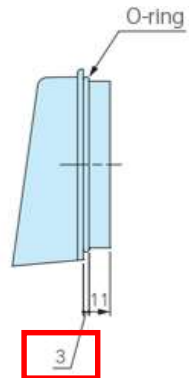

#### New O-ring:

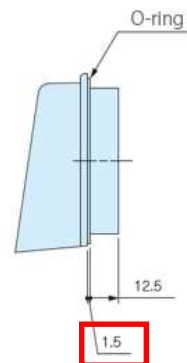
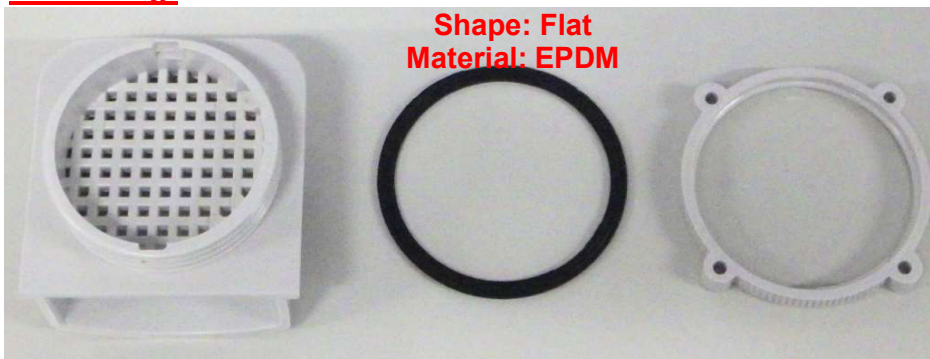

- **Functionality**: No changes to functionality.
- **Purpose**: To ensure consistent quality throughout via streamlined supply chain and materials.
- **Period**: Once current inventory has been depleted.
- **Note** : No changes to Series, Product number, or pricing.

Thank you for your understanding.

For more information, kindly contact us at: [sales@takachi-el.co.jp](mailto:sales@takachi-el.co.jp)

V series

VENTILATION LOUVER



- Recommended for condensation prevention and heat dissipation.
- 2 models available : ABS V60, V80 match the color for BCAP and BCAR series, and polycarbonate V60S and V80S match the color for BCPC, BCPK, and BCAR series.
- Suitable to be used on a variety of enclosure types, series and models.

V dimensions

■ DXF/DWG/PDF drawings available on our website.

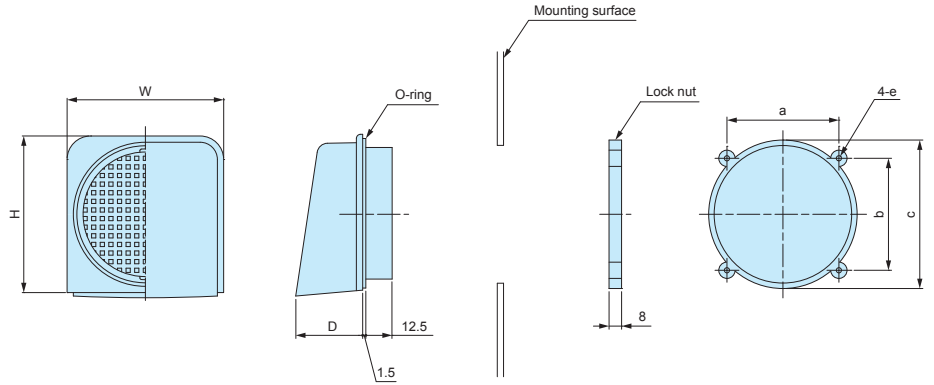

Product no. / Dimensions

Product no.	Material	Color	Mount hole	W	H	D	a	b	c	e
V60	ABS	White gray	Φ63	74	74	31.8	50.5	50.5	70	Φ3.8
V80	ABS	White gray	Φ88	100	100	37	71.5	71.5	94.8	Φ3.3
V60S	Polycarbonate	Light gray	Φ63	74	74	31.8	50.5	50.5	70	Φ3.8
V80S	Polycarbonate	Light gray	Φ88	100	100	37	71.5	71.5	94.8	Φ3.3

■ O-ring material : EPDM / Black

VF series

VENTILATION PARTS

VF dimensions

■ DXF/DWG/PDF drawings available on our website.

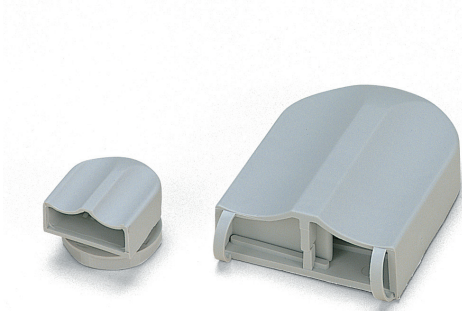

VF-1

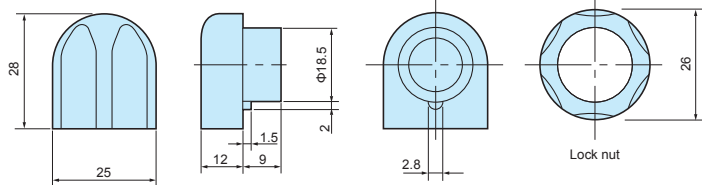

Hole layout for mounting

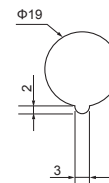

VF-2

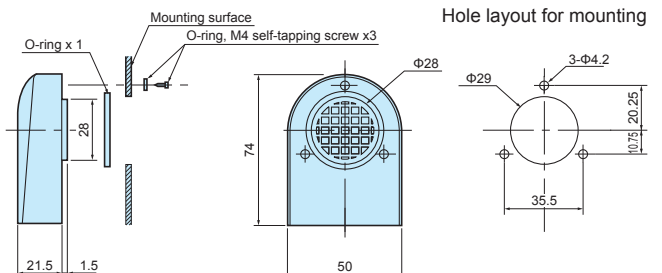

Hole layout for mounting

Technical Data

Protection class : VF-1 IP33  
VF-2 IP24

Product no. / Dimensions

Product no.	Material / Color
VF-1	Polyamide / White gray
VF-2	Polyamide / White gray