

THB390T•402T series

IP68 T-SHAPED RELAY CONNECTOR



- IP68 3 ways relay connector for branching of cables or for connecting devices in a daisy chain.
- A screw type wiring connection is adopted, allowing for easy installation and removal.
- 3P, 6P and 3WP pole terminal models and no terminal model are available.
- Possible to adopt wide cable range with the optional sealing insert.
(See page Tool-5 for the details.)
- Screws may be screwed in firmly. Use a screwdriver with proper grip handles to loosen it.



Technical Data	
Protection class :	IP68 2bar/1h (1 hour / 20m depth)
Operating temperature :	-40°C ~ +125°C
EN60529 :	1991+A1 : 2000,
EN60998-1 :	2004,
EN60998-2-1 :	2004 compliant

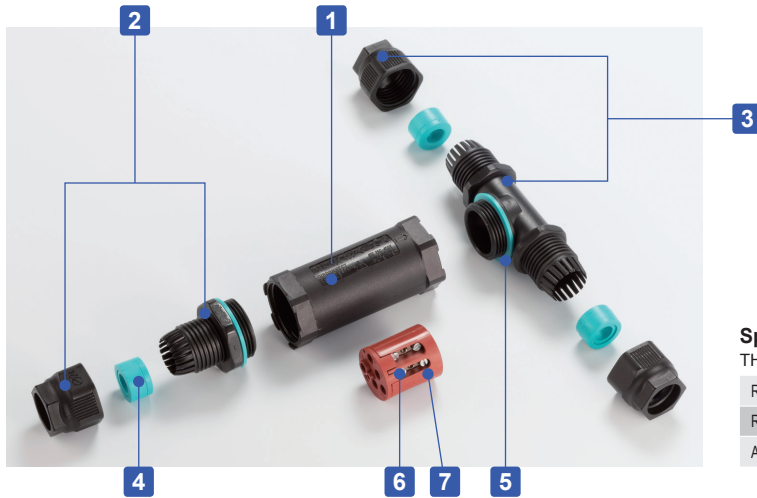

- Applicable cable size range can be expanded by removing the inner sealing insert.

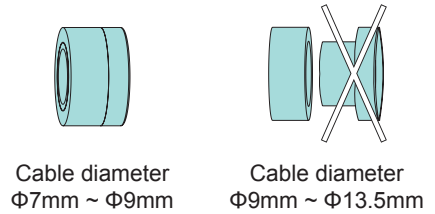

Specifications

	THB390T-3P • THB402T-6P	THB402T-3WP
Rated voltage	AC250V	Rated voltage AC250V
Rated current	24A	Rated current 32A
Applicable wire	Stranded wire 0.5mm ² ~ 2.5mm ²	Applicable wire Stranded wire 0.5mm ² ~ 4.0mm ²

Components

No.	Part name	Pcs	Material	Color / Finish
1	Body	1	PA66GF (UL94V-0)	Black
2	Cable gland	1	PA66 (UL94V-2)	Black
3	T-shaped cable gland	1	PA66 (UL94V-2)	Black
4	Sealing insert	3	TPE	Green
5	Gasket	2	Silicone	Green
6	Terminal	1	PA66GF (UL94V-0)	Black • Brown
7	Terminal screw (M3 slotted)	6 ~ 12	Steel	Zinc plated

■ PA66 = Polyamide 66
■ PA66GF = Glass fiber filled polyamide 66

Accessories

(Optional parts)

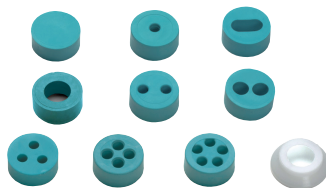

Sealing insert
See page Tool-5



Exclusive bracket
See page Tool-6



Exclusive tightening tool
See page Tool-5

Product no. / Details

Product no.	L1	L2	D	Cable range	Number of poles
THB390T-3P	79	97	32	Φ7 ~ Φ13.5	3P
THB402T-6P	124	97	32	Φ7 ~ Φ13.5	6P
THB402T-3WP	124	97	32	Φ7 ~ Φ13.5	3WP
THB402T-N	124	97	32	Φ7 ~ Φ13.5	None

■ DXF/DWG/PDF drawings available on our website.

THB390T

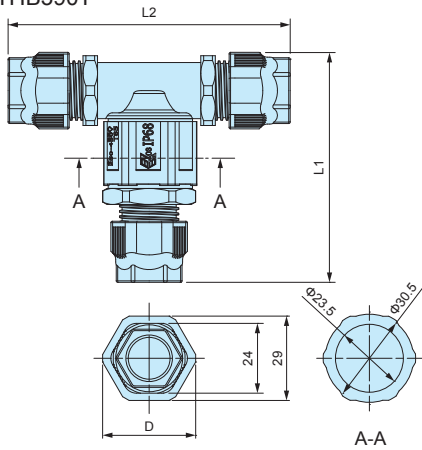

3P Terminal

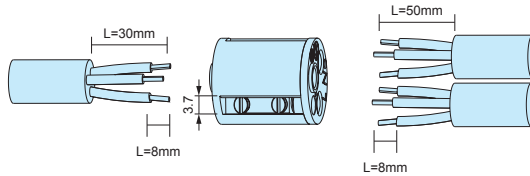

Wire connection diagram

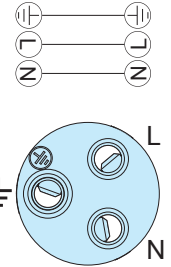

■ A flathead (minus) screwdriver of tip width 3mm is recommended to be used.

THB402T

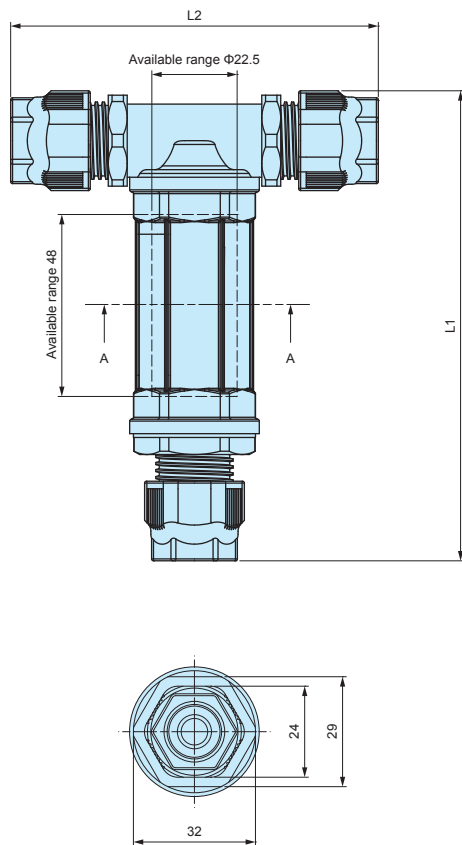

THB402T-6P (Terminal model)

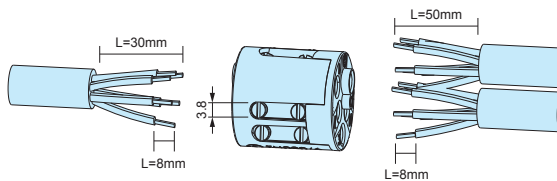

Wire connection diagram

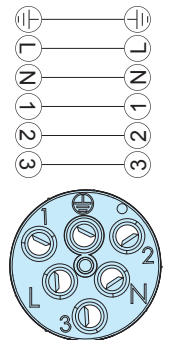

■ A flathead (minus) screwdriver of tip width 3mm is recommended to be used.

THB402T-3WP (Terminal model)

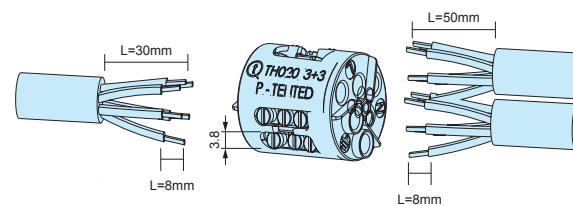

Wire connection diagram

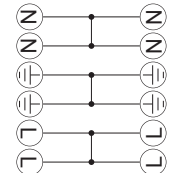

Two poles are divided into three. (Each is common)

■ A flathead (minus) screwdriver of tip width 3mm is recommended to be used.

THB402T-N (No terminal model)

- No terminal model.
- Use when utilizing other terminals or connecting without terminal.



SEALING INSERT for THA • THB • THS

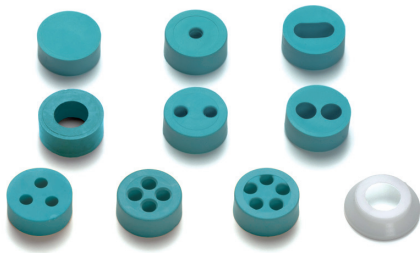

- Optional sealing insert for THA209, THB387L, 387LE, 389, 389E, 390, 399Y, 400, 402T, 405, 406, THS389 and 389E.
(Not applicable to be used for THB381, 381E, 387, 387E, 391 and 392 series.)
- Recommended to be used to change the compatible wire diameter, or for installation of multiple wires.
- 6000087LF cap can be used to prevent the rubber bushing from protruding, as well as stabilizing the waterproof performance when using wire of diameter 7.0mm or smaller.

Product no. / Details

Product no.	Appearance	Cable range	Material	Pack of
600013700		Blind insert without hole	TPE	10
600012700		11mm × 5.5mm	TPE	10
600037000		Φ4.0 ~ Φ6.5mm	TPE • POM	10 each
604001100		Φ5.5 ~ Φ9.5mm Use fixing cap for cables sized Φ7.0mm or smaller	TPE • POM	10 each
600013600		Φ2.0 ~ Φ4.0mm	TPE • POM	10 each
600012500		Φ2.0 ~ Φ4.0mm	TPE • POM	10 each
600030600		Φ4.5 ~ Φ6.0mm	TPE	10
600012600		Φ2.0 ~ Φ4.0mm	TPE	10
600018200		Φ2.0 ~ Φ3.5mm	TPE	10
600022400		Φ2.5 ~ Φ3.5mm	TPE	10
6000087LF		Cap for cables sized Φ7.0mm or smaller	POM	10

■ 6000087LF cap cannot be used with 600030600 and 600022400

EXCLUSIVE TIGHTENING TOOL for THB • THS



How to use

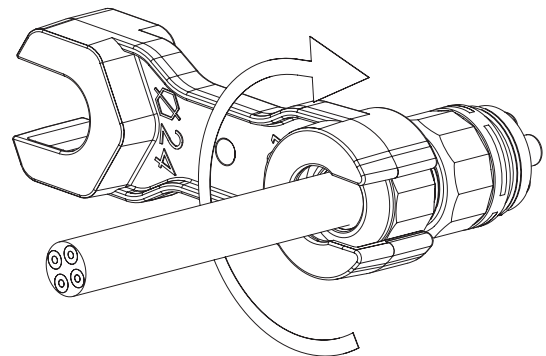

■ Dedicated locking tool for tightening of the cable gland cap.

Product no. / Details

Product no.	Material / Color	Suitable models
6000337BC	PA66GF / Black	THB387 • 387E • 387L • 387LE • 389 • 389E • 390 • 390T • 391 • 392 • 399Y • 400 • 402T • 405 • 406 • THS389 • 389E

■ PA66GF = Glass fiber filled polyamide 66

EXCLUSIVE BRACKET for THB

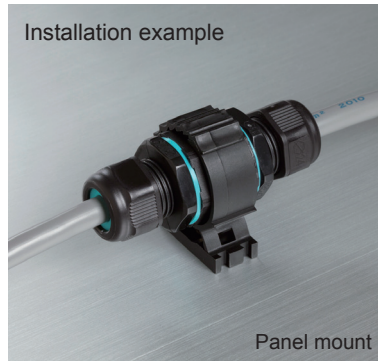
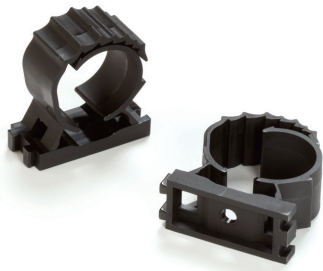

- Optional bracket for affixing onto panels, poles etc.
- Recommended for affixing / securing connectors onto a surface.

■ DXF/DWG/PDF drawings available on our website.

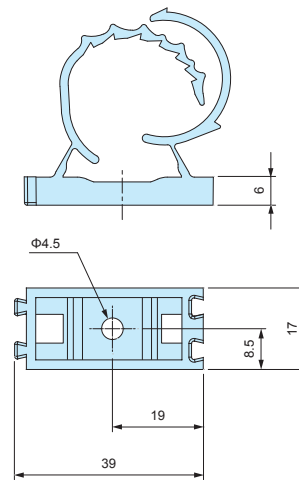

Product no. / Details

■ PA66 = Polyamide 66

Product no.	Material / Color	Suitable models
6000302CC	PA66 / Black	THB387 • 387L • 390 • 390T • 391 • 399Y • 400 • 402T • 405

Application Example - Waterproof Connector

Outdoor LED Lighting Connection

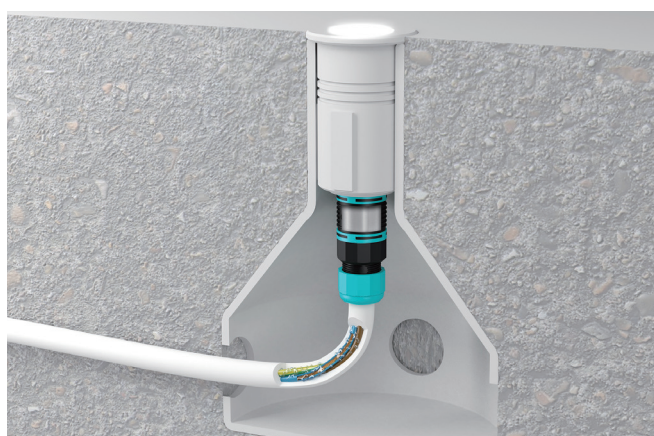
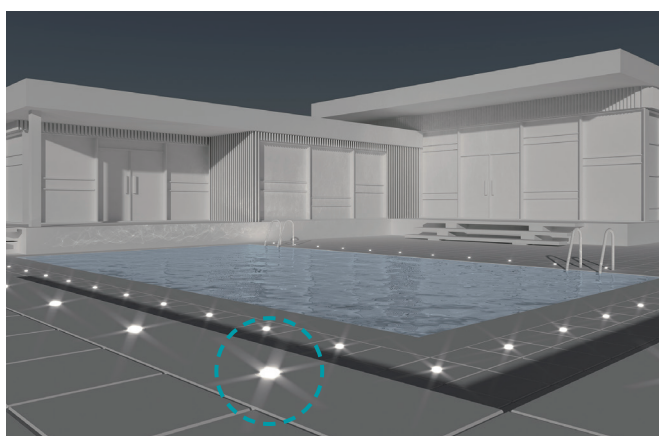
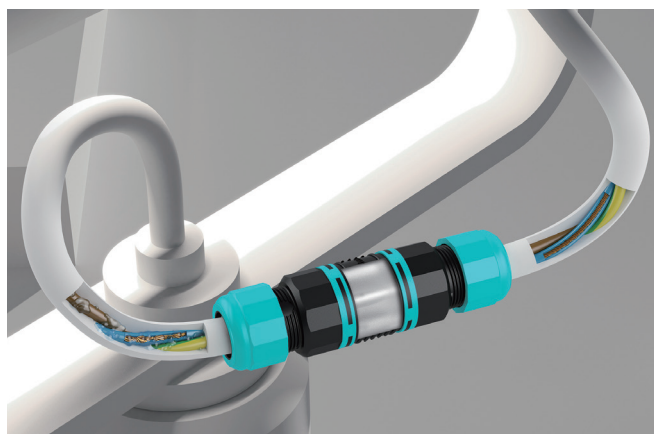
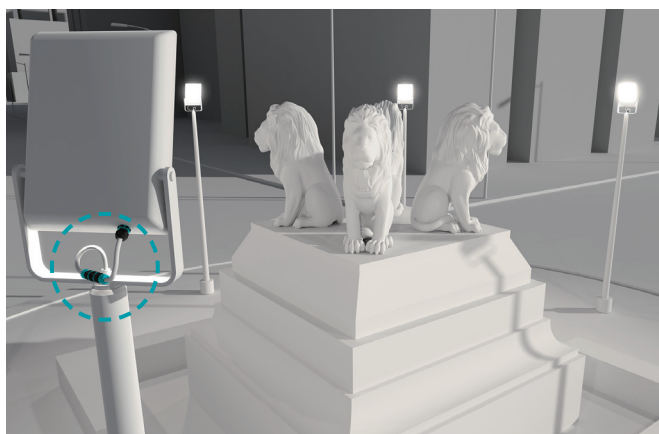

Application Example-1

Industrial Motor Connection

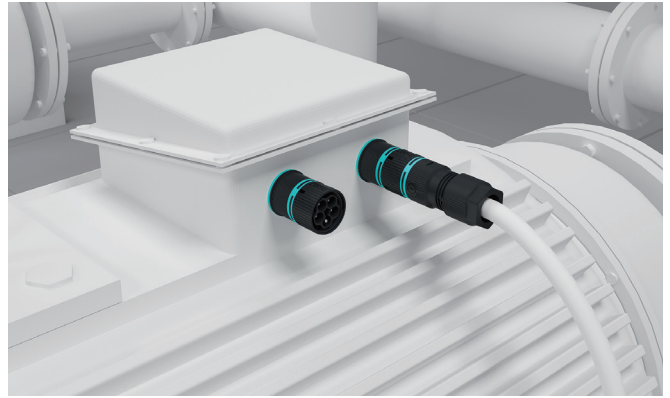
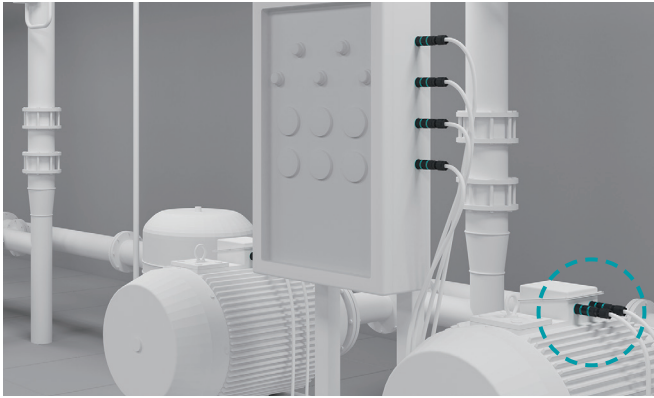

Sprinkler System Connection

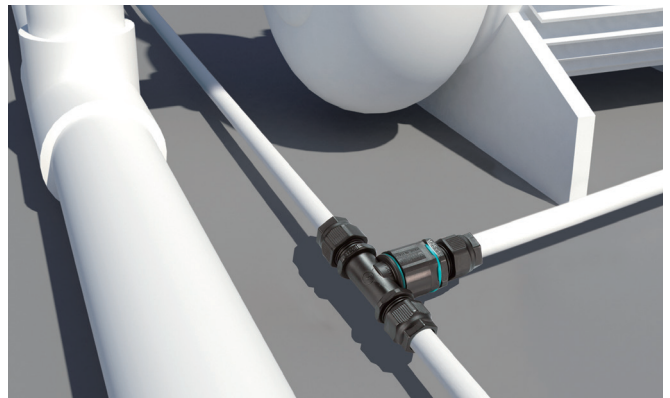
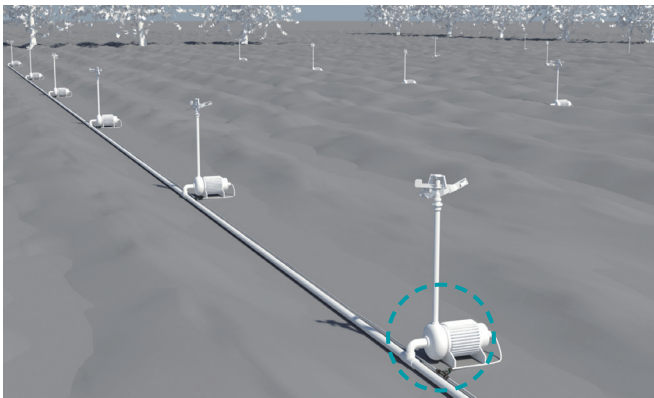

Power / Sensor Signal Relay in Factory Automation

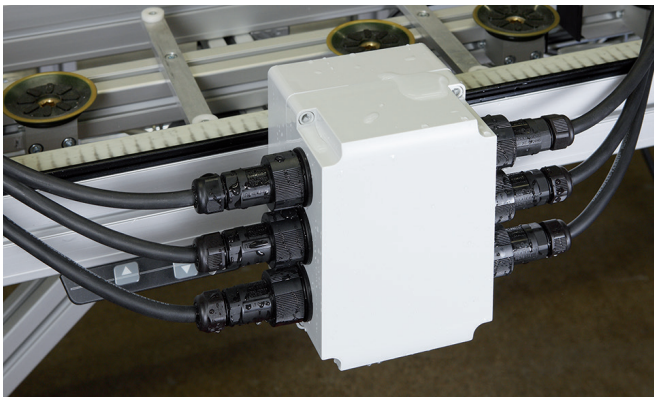

Machinery



Circuit Breaker Connector



Underground • Underfloor Wiring

