

THB392 series

IP68 H-SHAPED COMPACT RELAY CONNECTOR



- IP68 4 ways compact relay connector with an integrated cable gland and terminal block structure.
- A screw type wiring connection is adopted, allowing for easy installation and removal.
- 4P x 4 common pole terminal model.

Technical Data	
Protection class :	IP68 3bar/2h (2hours / 30m depth)
Operating temperature :	-40°C ~ +125°C
	EN60529, EN60998 compliant



Specifications

Rated voltage	AC450V
Rated current	17.5A
Applicable wire	Stranded wire 0.5mm ² ~ 4.0mm ²

Components

- PA66 = Polyamide 66
- PA66GF = Glass fiber filled polyamide 66

No.	Part name	Pcs	Material	Color / Finish
1	Body	1	PA66GF (UL94V-0) • TPE	Black • Green
2	Cable gland	4	PA66 (UL94V-2)	Black
3	Sealing insert	4	TPE	Green
-	Terminal	4P x 4	Brass	Nickel plated
-	Terminal screw (M3 slotted)	16	Steel	Zinc plated

- Suitable for use as power or sensor signal relay of industrial plant, machining instrument, outdoor LED lighting, underground wiring, marine equipment where waterproof is required.

Installation example

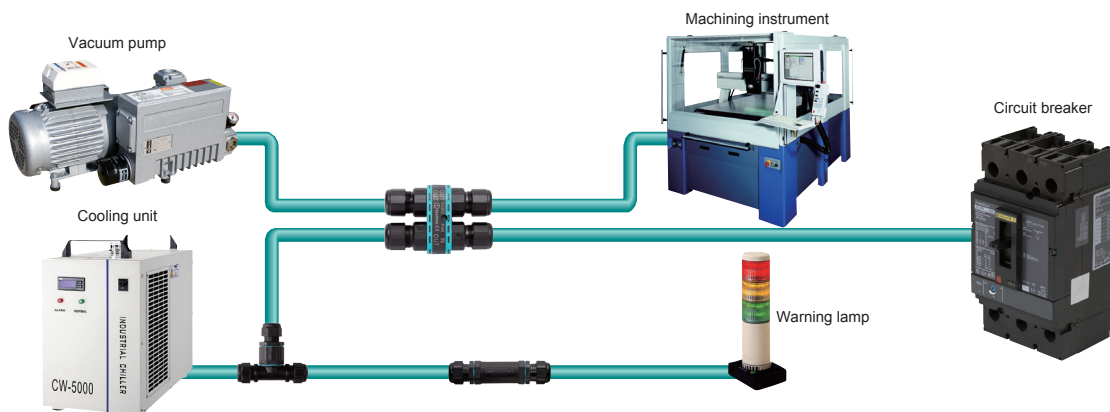

Accessories (Optional parts)



Sealing insert
See page Tool-5



Exclusive tightening tool
See page Tool-5

How to connect wire



Insert the wires according to the terminal numbers.

- A flathead (minus) screwdriver of tip width 3mm is recommended to be used.
- Screws may be screwed in firmly. Use a screwdriver with proper grip handles to loosen it.



Tighten screws to secure the connection.

Terminal connection diagram

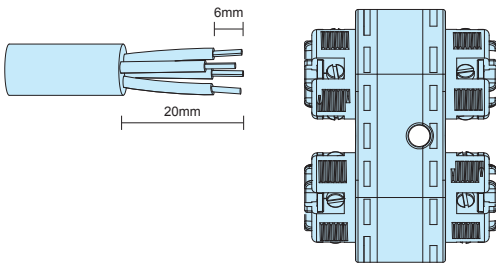

THB392 dimensions

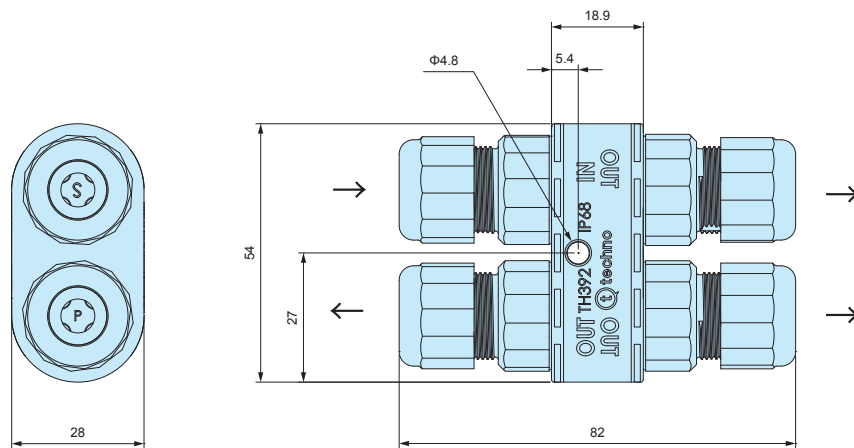

- DXF/DWG/PDF drawings available on our website.

- IN and OUT directions are fixed.
Confirm direction before use.

Diagram

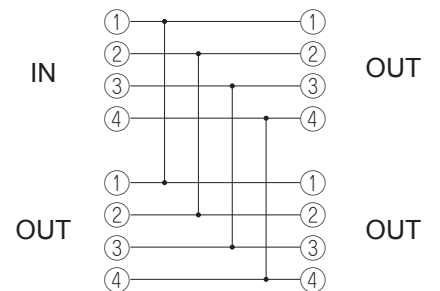

Product no. / Details

Product no.	Cable range	Number of poles
THB392-4P	Φ7 ~ Φ12	4P×4

SEALING INSERT for THB387 • 387E • 391 • 392

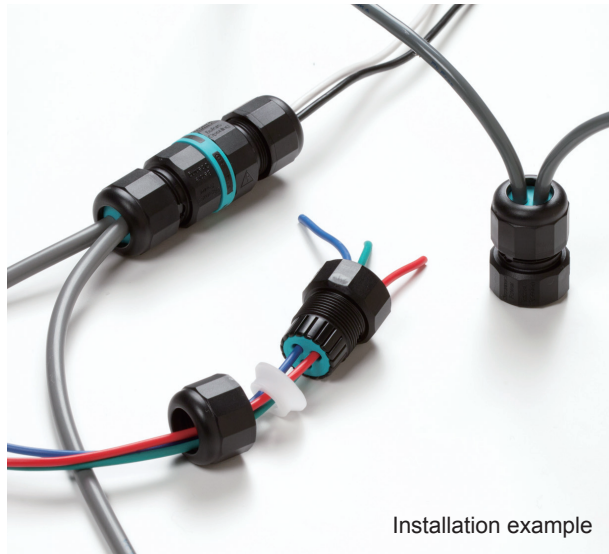

Installation example

- Optional sealing insert for THB387, 387E, 391 and 392 series.
- Recommended to be used to change the compatible wire diameter, or for installation of multiple wires.
- 6000347LA cap can be used to prevent the rubber bushing from protruding, as well as stabilizing the waterproof performance when using wire of diameter 7.0mm or smaller.
- Not applicable to be used for THA209, THB381, 381E, 387L, 387LE, 389, 389E, 390, 399Y, 400, 402T, 405, 406 series.

Product no. / Details

Product no.	Appearance	Cable range	Material	Pack of
6000338GT		Blind insert without hole	TPE	10
6000377GT		Φ2.5 ~ Φ4.0mm	TPE • POM	10 each
6000339GT		Φ5.0 ~ Φ7.0mm	TPE • POM	10 each
6000340GT		Φ3.0 ~ Φ4.5mm	TPE • POM	10 each
6000341GT		Φ4.5 ~ Φ6.0mm	TPE	10
6000342GT		Φ2.5 ~ Φ4.5mm	TPE	10
6000343GT		Φ2.5 ~ Φ4.0mm	TPE	10
6000347LA		Cap for cables sized Φ7.0mm or smaller	POM	10

- 6000347LA cap cannot be used with 6000341GT and 6000343GT.

SEALING INSERT for THA • THB • THS

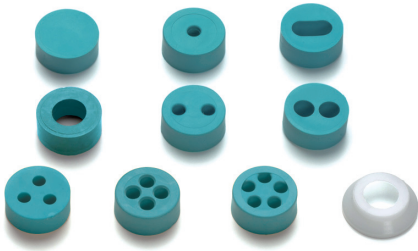

- Optional sealing insert for THA209, THB387L, 387LE, 389, 389E, 390, 399Y, 400, 402T, 405, 406, THS389 and 389E.
(Not applicable to be used for THB381, 381E, 387, 387E, 391 and 392 series.)
- Recommended to be used to change the compatible wire diameter, or for installation of multiple wires.
- 6000087LF cap can be used to prevent the rubber bushing from protruding, as well as stabilizing the waterproof performance when using wire of diameter 7.0mm or smaller.

Product no. / Details

Product no.	Appearance	Cable range	Material	Pack of
600013700		Blind insert without hole	TPE	10
600012700		11mm × 5.5mm	TPE	10
600037000		Φ4.0 ~ Φ6.5mm	TPE • POM	10 each
604001100		Φ5.5 ~ Φ9.5mm Use fixing cap for cables sized Φ7.0mm or smaller	TPE • POM	10 each
600013600		Φ2.0 ~ Φ4.0mm	TPE • POM	10 each
600012500		Φ2.0 ~ Φ4.0mm	TPE • POM	10 each
600030600		Φ4.5 ~ Φ6.0mm	TPE	10
600012600		Φ2.0 ~ Φ4.0mm	TPE	10
600018200		Φ2.0 ~ Φ3.5mm	TPE	10
600022400		Φ2.5 ~ Φ3.5mm	TPE	10
6000087LF		Cap for cables sized Φ7.0mm or smaller	POM	10

■ 6000087LF cap cannot be used with 600030600 and 600022400

EXCLUSIVE TIGHTENING TOOL for THB • THS



How to use

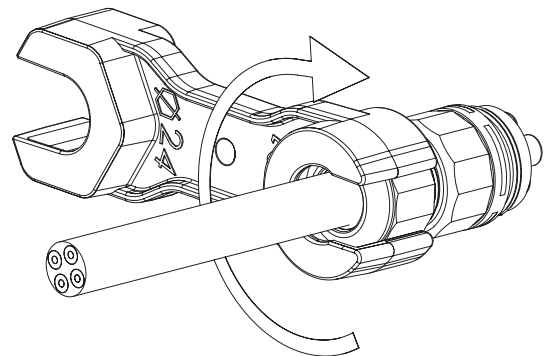

- Dedicated locking tool for tightening of the cable gland cap.

Product no. / Details

Product no.	Material / Color	Suitable models
6000337BC	PA66GF / Black	THB387 • 387E • 387L • 387LE • 389 • 389E • 390 • 390T • 391 • 392 • 399Y • 400 • 402T • 405 • 406 • THS389 • 389E

■ PA66GF = Glass fiber filled polyamide 66

EXCLUSIVE BRACKET for THB



- Optional bracket for affixing onto panels, poles etc.
- Recommended for affixing / securing connectors onto a surface.

■ DXF/DWG/PDF drawings available on our website.

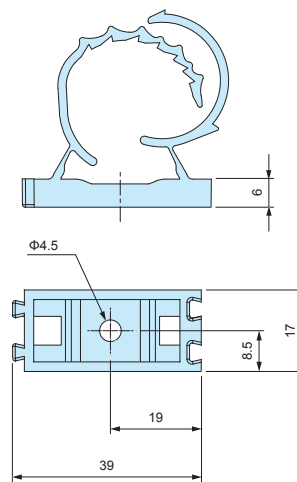

Product no. / Details

■ PA66 = Polyamide 66

Product no.	Material / Color	Suitable models
6000302CC	PA66 / Black	THB387 • 387L • 390 • 390T • 391 • 399Y • 400 • 402T • 405

Application Example - Waterproof Connector

Outdoor LED Lighting Connection

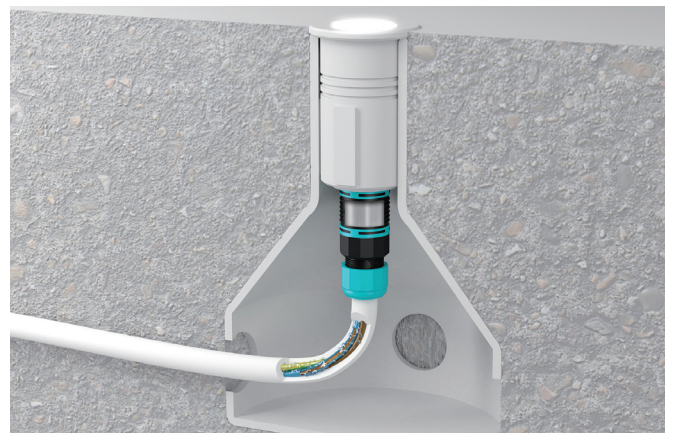
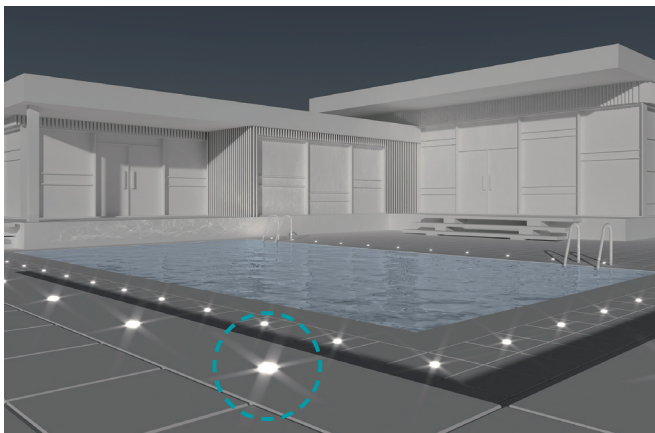
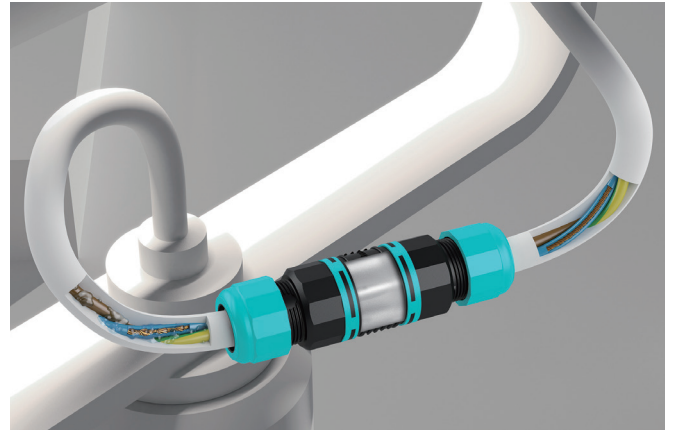
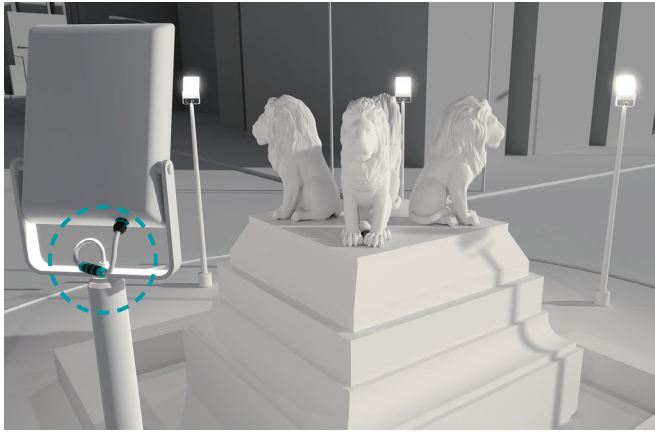

Application Example-1

Industrial Motor Connection

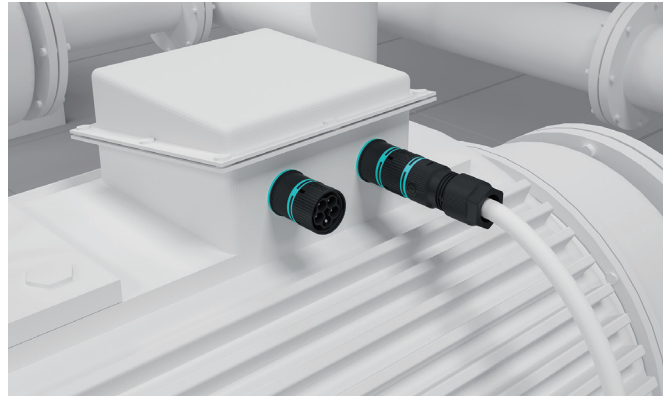
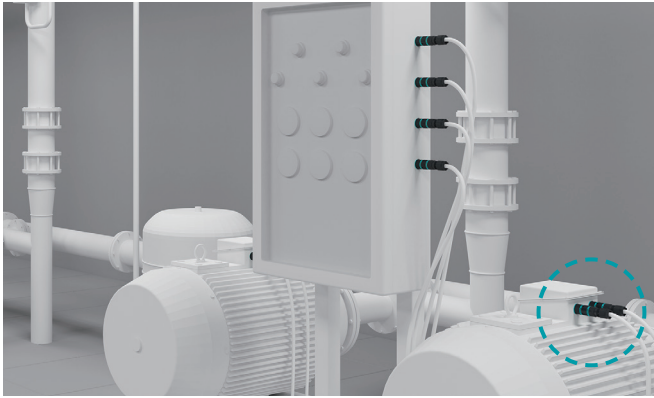

Sprinkler System Connection

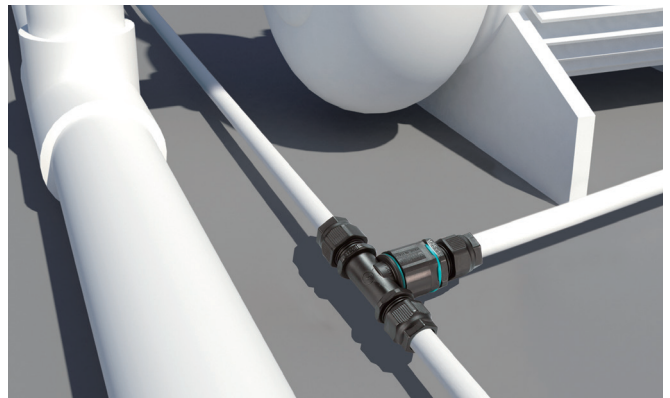
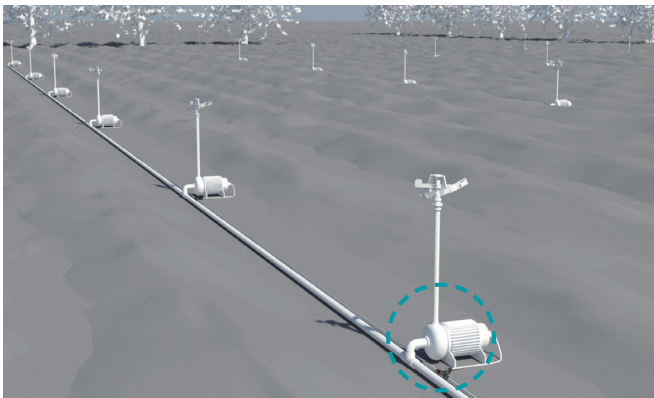

Power / Sensor Signal Relay in Factory Automation

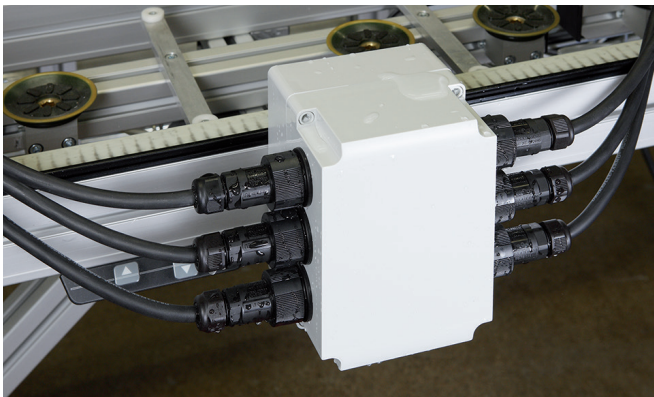

Machinery



Circuit Breaker Connector



Underground • Underfloor Wiring

