

THB387L series

IP68 UL CERTIFIED MINI PLUG-TYPE RELAY CONNECTOR



- UL2238 / C22.2 No. 182.3 certified products.
- Plug-socket connector type consisting of the plug side (male) and socket side (female).
- A screw type wiring connection is adopted, allowing for easy installation and removal.
- 4P and 5P pole models are available.
- For safety reasons, please arrange the connector such that the primary side is female (socket side) and the secondary side is male (plug side).

Technical Data

Protection class : IP68 3bar/3h (3 hour / 30m depth)
 Operating temperature : -40°C ~ +125°C
 EN61984 compliant.

Specifications

THB387L-4P

Rated voltage	Max AC500V
Rated current	Max 17.5A (EN61984)
	Max 15A (UL2238/C22.2 No. 182.3)
Applicable wire	Stranded wire 0.5mm ² ~ 4.0mm ²
Impulse withstand voltage	4kV
Number of insertion/extraction	1,000 times

THB387L-5P

Rated voltage	Max AC500V
Rated current	Max 17.5A (EN61984)
	Max 10A (UL2238/C22.2 No. 182.3)
Applicable wire	Stranded wire 0.25mm ² ~ 1.5mm ²
Impulse withstand voltage	4kV
Number of insertion/extraction	1,000 times



Components

No.	Part name	Pcs	Material	Color / Finish
1	Plug	1	PA66GF (UL94V-0) • PA66 • TPE	Black • Green
2	Socket	1	PA66GF (UL94V-0) • PA66 • TPE	Black • Green
3	Cable gland	2	PA66 (UL94V-2)	Black
4	Sealing insert	2	TPE	Green

■ PA66 = Polyamide 66
 ■ PA66GF = Glass fiber filled polyamide 66

Accessories (Optional parts)



Sealing insert
See page Tool-5



Exclusive bracket
See page Tool-6



Sealing plug • socket cap
See page Cap-3



Exclusive tightening tool
See page Tool-5

Terminal sequence

Plug side (Male)



THB387L-4P



THB387L-5P



Socket side (Female)



THB387L-4P



THB387L-5P



Wire connection diagram

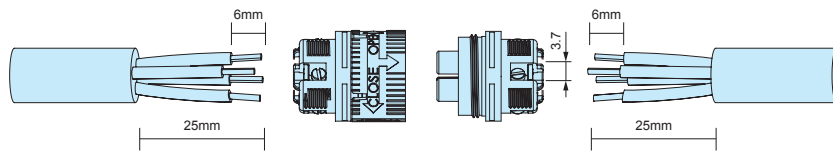

- Screw type connection method; soldering or special tools are not required.
- A flathead (minus) screwdriver of tip width 3mm is recommended.
- Screws may be screwed in firmly. Use a screwdriver with proper grip handles to loosen it.

THB387L dimensions

■ DXF/DWG/PDF drawings available on our website.

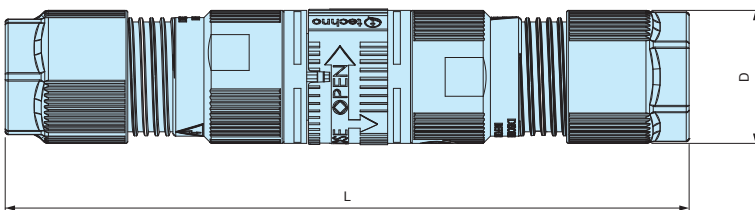

Sealing insert

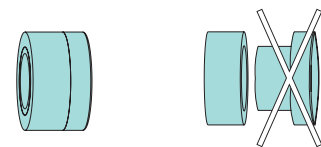

Cable diameter
Φ7.0 ~ Φ9mm

Cable diameter
Φ9mm ~ Φ13.5mm

- Applicable cable size range can be expanded by removing the inner sealing insert.

Product no. / Details

Product no.	L	D	Cable range	Number of poles
THB387L-4P	118	23	Φ7.0 ~ Φ13.5	4P
THB387L-5P	118	23	Φ7.0 ~ Φ13.5	5P

THB387LE series

IP68 UL CERTIFIED MINI PANEL-MOUNT PLUG-TYPE RELAY CONNECTOR

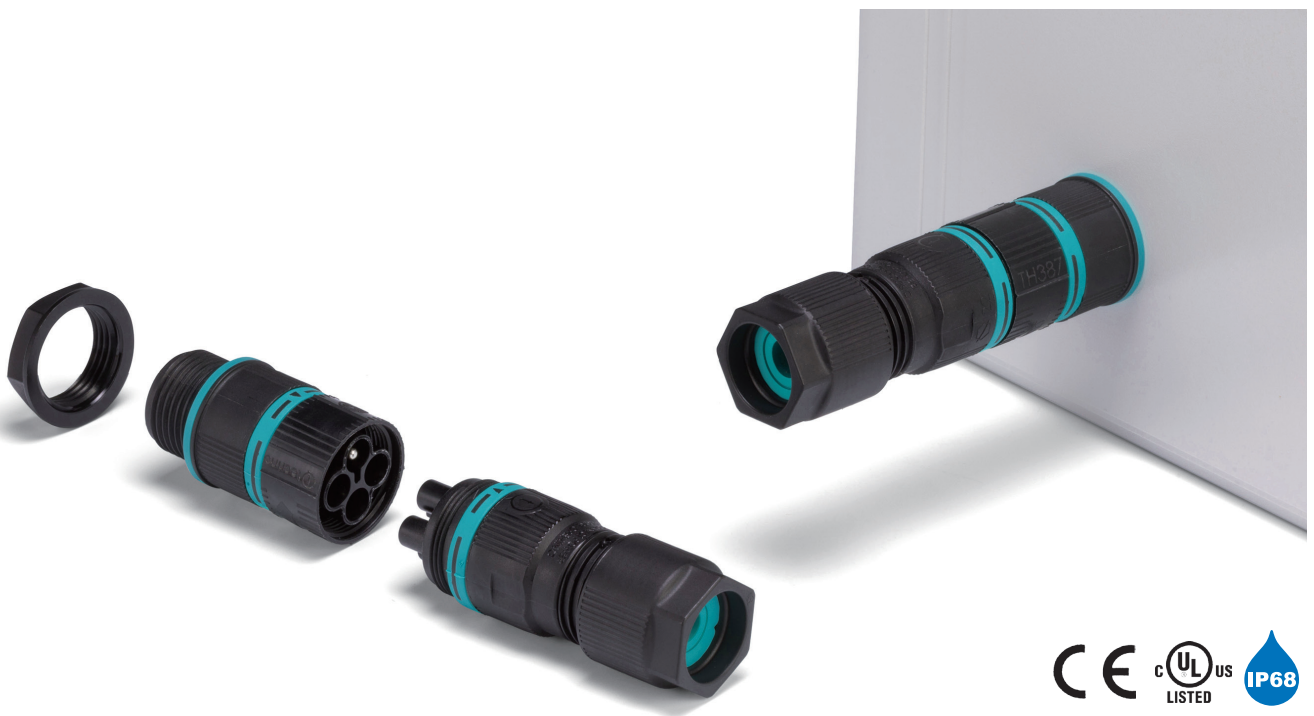

- UL2238 / C22.2 No. 182.3 certified products.
- Plug-socket panel-mount type consisting of the plug side (male) and socket side (female).
- Can be attached / detached while installed on panels or enclosures.
- A screw type wiring connection is adopted, allowing for easy installation and removal.
- 4P and 5P pole models are available.
- For safety reasons, please arrange the connector such that the primary side is female (socket side) and the secondary side is male (plug side).

Technical Data
Protection class : IP68 3bar/3h (3 hour / 30m depth) Operating temperature : -40°C ~ +125°C EN61984 compliant.

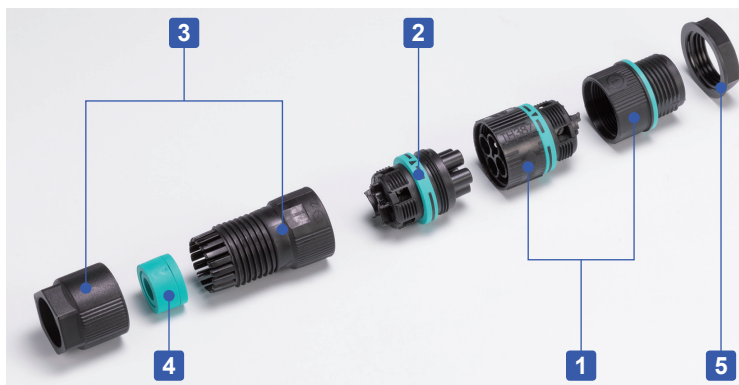

Specifications

THB387LE-4P

Rated voltage	Max AC500V
Rated current	Max 17.5A (EN61984)
	Max 15A (UL2238/C22.2 No. 182.3)
Applicable wire	Stranded wire 0.5mm ² ~ 4.0mm ²
Impulse withstand voltage	4kV
Number of insertion/extraction	1,000 times

THB387LE-5P

Rated voltage	Max AC500V
Rated current	Max 17.5A (EN61984)
	Max 10A (UL2238/C22.2 No. 182.3)
Applicable wire	Stranded wire 0.25mm ² ~ 1.5mm ²
Impulse withstand voltage	4kV
Number of insertion/extraction	1,000 times

Components

No.	Part name	Pcs	Material	Color / Finish
1	Plug	1	PA66GF (UL94V-0) • PA66 • TPE	Black • Green
2	Socket	1	PA66GF (UL94V-0) • PA66 • TPE	Black • Green
3	Cable gland	1	PA66 (UL94V-2)	Black
4	Sealing insert	1	TPE	Green
5	Lock nut	1	PA66 (UL94V-2)	Black

■ PA66 = Polyamide 66

■ PA66GF = Glass fiber filled polyamide 66

Accessories (Optional parts)



Sealing insert
See page Tool-5



Sealing plug • socket cap
See page Cap-3



Exclusive tightening tool
See page Tool-5

Terminal sequence

Plug side (Male)



THB387LE-4P



THB387LE-5P



Socket side (Female)



THB387LE-4P

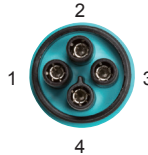

THB387LE-5P



Wire connection diagram

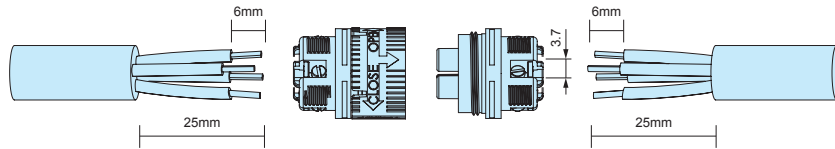

- Screw type connection method; soldering or special tools are not required.
- A flathead (minus) screwdriver of tip width 3mm is recommended.
- Screws may be screwed in firmly. Use a screwdriver with proper grip handles to loosen it.

THB387LE dimensions

■ DXF/DWG/PDF drawings available on our website.

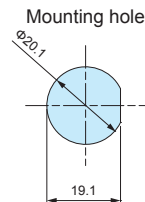
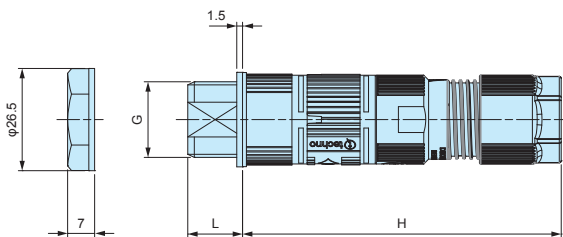

Sealing insert

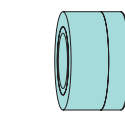

Cable diameter
Φ7mm ~ Φ9mm

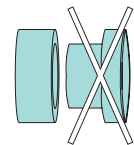

Cable diameter
Φ9mm ~ Φ13.5mm

- Applicable cable size range can be expanded by removing the inner sealing insert.

Product no. / Details

Product no.	L	D	G	Cable range	Number of poles
THB387LE-4P-M20	14	82	20	Φ7.0 ~ Φ13.5	4P
THB387LE-5P-M20	14	82	20	Φ7.0 ~ Φ13.5	5P

SEALING INSERT for THB387 • 387E • 391 • 392



Installation example

- Optional sealing insert for THB387, 387E, 391 and 392 series.
- Recommended to be used to change the compatible wire diameter, or for installation of multiple wires.
- 6000347LA cap can be used to prevent the rubber bushing from protruding, as well as stabilizing the waterproof performance when using wire of diameter 7.0mm or smaller.
- Not applicable to be used for THA209, THB381, 381E, 387L, 387LE, 389, 389E, 390, 399Y, 400, 402T, 405, 406 series.

Product no. / Details

Product no.	Appearance	Cable range	Material	Pack of
6000338GT		Blind insert without hole	TPE	10
6000377GT		Φ2.5 ~ Φ4.0mm	TPE • POM	10 each
6000339GT		Φ5.0 ~ Φ7.0mm	TPE • POM	10 each
6000340GT		Φ3.0 ~ Φ4.5mm	TPE • POM	10 each
6000341GT		Φ4.5 ~ Φ6.0mm	TPE	10
6000342GT		Φ2.5 ~ Φ4.5mm	TPE	10
6000343GT		Φ2.5 ~ Φ4.0mm	TPE	10
6000347LA		Cap for cables sized Φ7.0mm or smaller	POM	10

- 6000347LA cap cannot be used with 6000341GT and 6000343GT.

SEALING PLUG CAP for THB387 • 387E • 387L • 387LE

■ DXF/DWG/PDF drawings available on our website.



Installation example on THB387



Installation example on THB387E



- Protect plug from dust or foreign objects when not in use. Material : Cap / Polyamide 66 • Ring / Silicone.
- Sealing plug caps are not waterproof.

Product no. / Details

Product no.	Suitable models
6DB0219M20	THB387 • 387E • 387L • 387LE - Plug side

SEALING SOCKET CAP for THB387 • 387E • 387L • 387LE



Installation example on THB387



Installation example on THB387E



- Protect socket from dust or foreign objects when not in use. Material : Cap / Polyamide 66 • Ring / Silicone.
- Sealing socket caps are not waterproof.

Product no. / Details

Product no.	Suitable models
6DB0234M20	THB387 • 387E • 387L • 387LE - Socket side

EXCLUSIVE BRACKET for THB

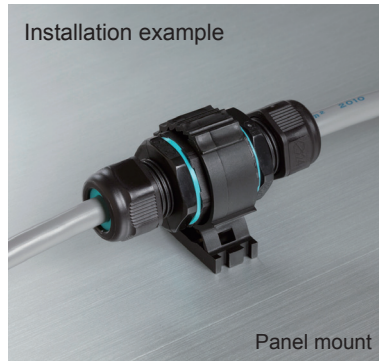

- Optional bracket for affixing onto panels, poles etc.
- Recommended for affixing / securing connectors onto a surface.

■ DXF/DWG/PDF drawings available on our website.

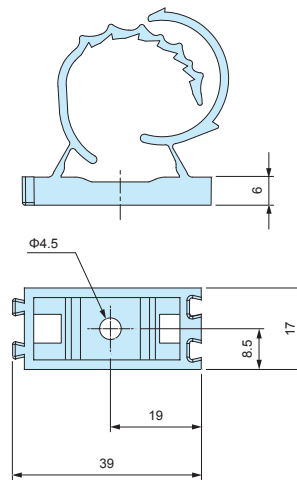

Product no. / Details

■ PA66 = Polyamide 66

Product no.	Material / Color	Suitable models
6000302CC	PA66 / Black	THB387 • 387L • 390 • 390T • 391 • 399Y • 400 • 402T • 405

SEALING INSERT for THA • THB • THS

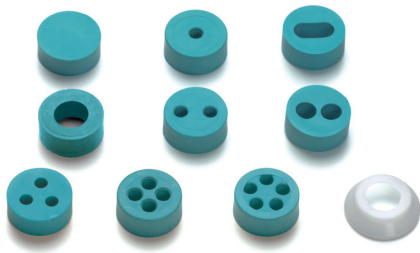

- Optional sealing insert for THA209, THB387L, 387LE, 389, 389E, 390, 399Y, 400, 402T, 405, 406, THS389 and 389E.
(Not applicable to be used for THB381, 381E, 387, 387E, 391 and 392 series.)
- Recommended to be used to change the compatible wire diameter, or for installation of multiple wires.
- 6000087LF cap can be used to prevent the rubber bushing from protruding, as well as stabilizing the waterproof performance when using wire of diameter 7.0mm or smaller.

Product no. / Details

Product no.	Appearance	Cable range	Material	Pack of
600013700		Blind insert without hole	TPE	10
600012700		11mm × 5.5mm	TPE	10
600037000		Φ4.0 ~ Φ6.5mm	TPE • POM	10 each
604001100		Φ5.5 ~ Φ9.5mm Use fixing cap for cables sized Φ7.0mm or smaller	TPE • POM	10 each
600013600		Φ2.0 ~ Φ4.0mm	TPE • POM	10 each
600012500		Φ2.0 ~ Φ4.0mm	TPE • POM	10 each
600030600		Φ4.5 ~ Φ6.0mm	TPE	10
600012600		Φ2.0 ~ Φ4.0mm	TPE	10
600018200		Φ2.0 ~ Φ3.5mm	TPE	10
600022400		Φ2.5 ~ Φ3.5mm	TPE	10
6000087LF		Cap for cables sized Φ7.0mm or smaller	POM	10

■ 6000087LF cap cannot be used with 600030600 and 600022400

EXCLUSIVE TIGHTENING TOOL for THB • THS



How to use

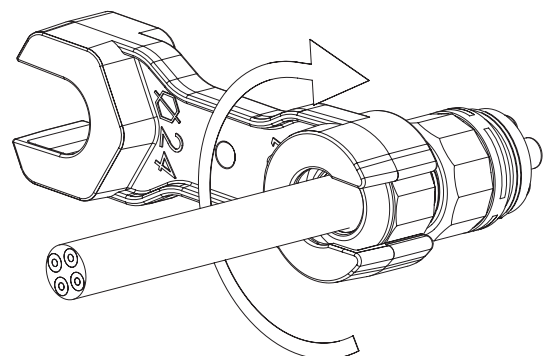

■ Dedicated locking tool for tightening of the cable gland cap.

Product no. / Details

Product no.	Material / Color	Suitable models
6000337BC	PA66GF / Black	THB387 • 387E • 387L • 387LE • 389 • 389E • 390 • 390T • 391 • 392 • 399Y • 400 • 402T • 405 • 406 • THS389 • 389E

■ PA66GF = Glass fiber filled polyamide 66

Application Example - Waterproof Connector

Outdoor LED Lighting Connection

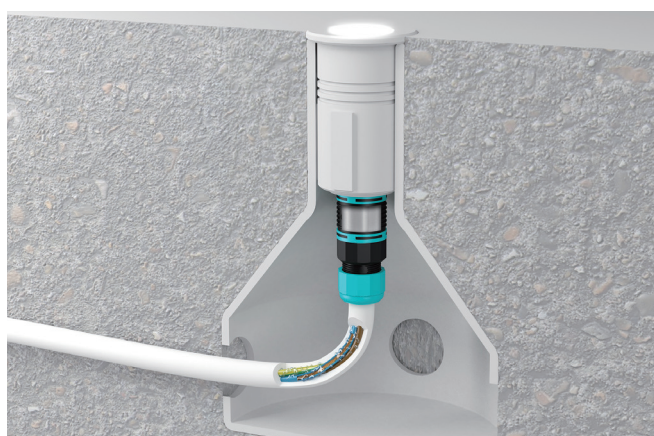
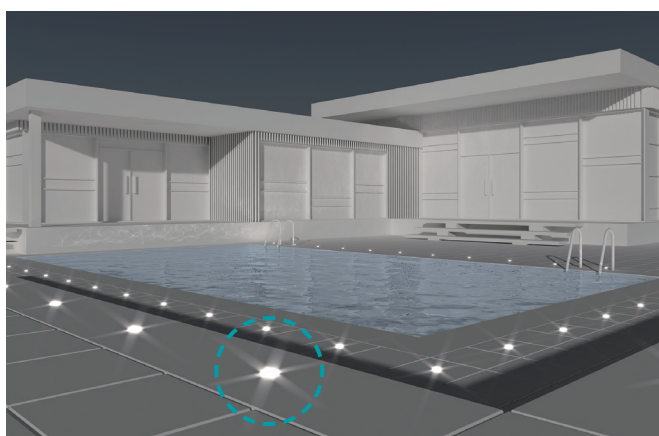
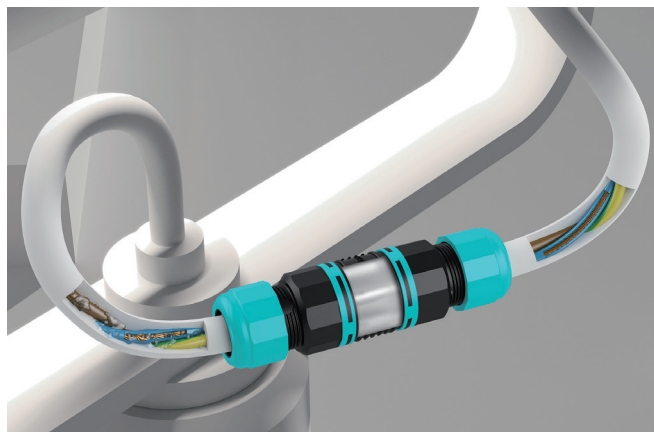
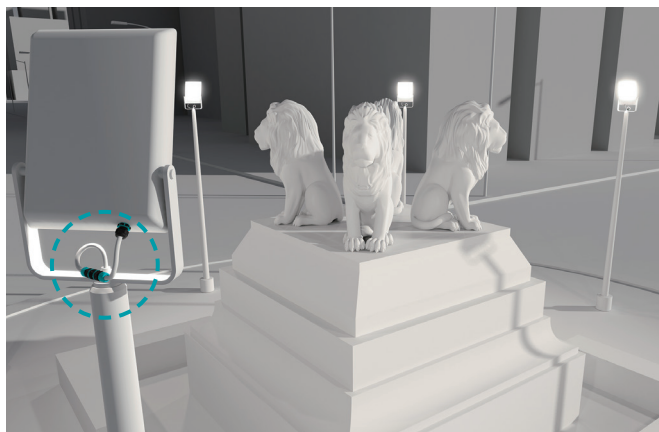

Application Example-1

Industrial Motor Connection

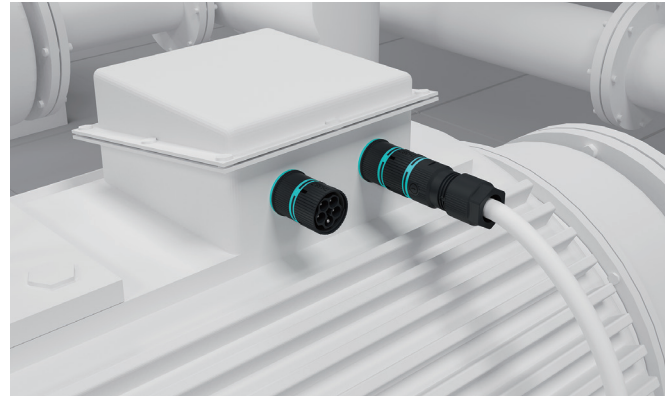
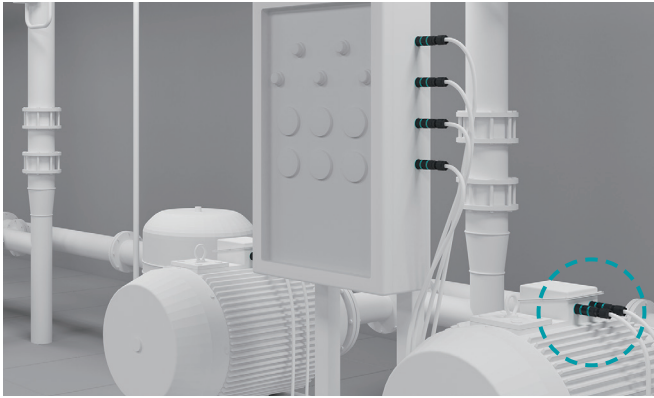

Sprinkler System Connection

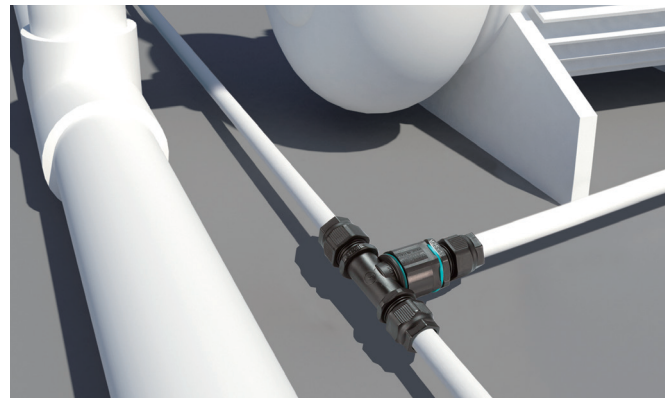
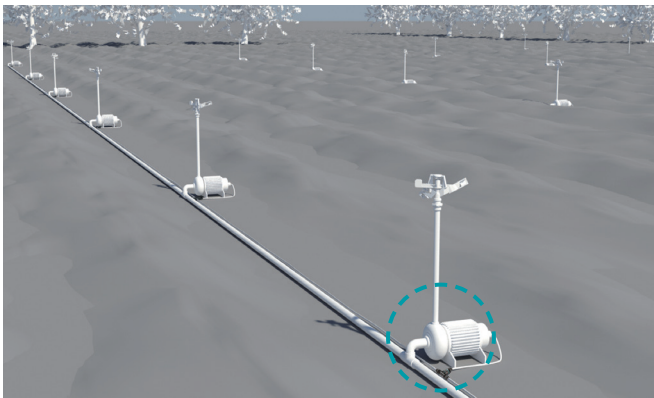

Power / Sensor Signal Relay in Factory Automation

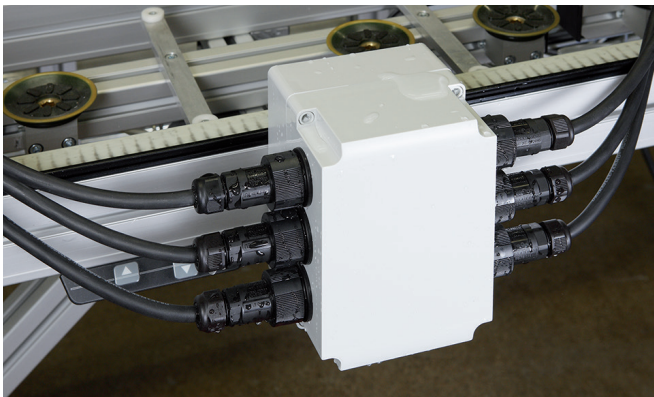

Machinery



Circuit Breaker Connector



Underground • Underfloor Wiring

