

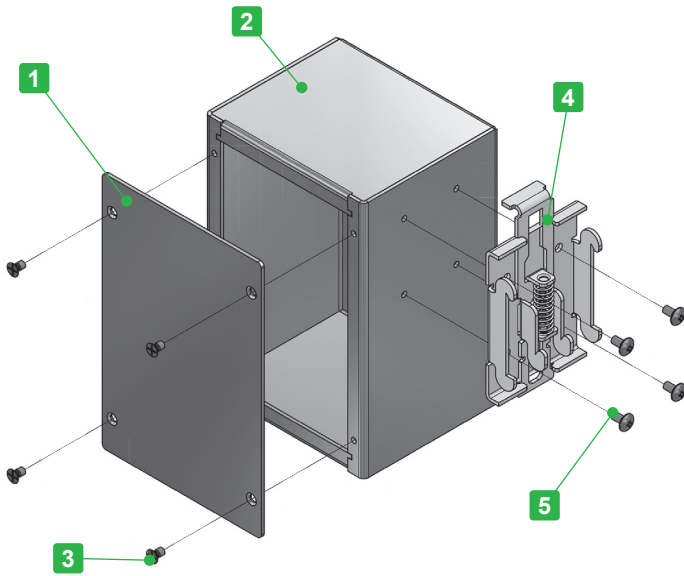

Technical Data
Max load : 3kg

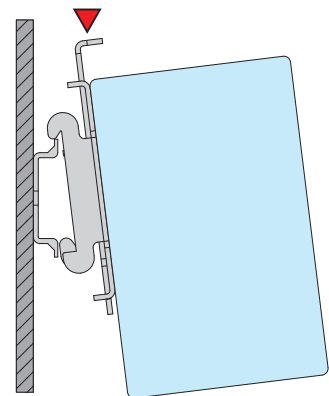

- Aluminium enclosure with mount bracket for 35mm DIN-rail.
 - Available in 6 different sizes.
 - Conductive finish on internal surface for conductivity and grounding.
 - Easy maintenance with detachable cover.
- Press the lever (denoted with a red sign below) when mounting / unmounting onto a DIN rail.



Components

No.	Part name	Pcs	Material	Color / Finish
1	Cover	1	Aluminium A1100P t = 1.5	Metallic silver / Painted (Conductive inside)
2	Base	1	Aluminium A1100P t = 1.5	Metallic silver / Painted (Conductive inside)
3	Screw (M3-5 flat head)	4	Steel	Nickel plated
4	DIN-rail mount bracket	1	Plated steel	Zinc plated
5	Screw (M3-5 pan head)	4	Steel	Trivalent chromate

■ Cover and Base are covered with a protective film on one side.

DRB dimensions

■ DXF/DWG/PDF drawings available on our website.

APPLICATION EXAMPLE

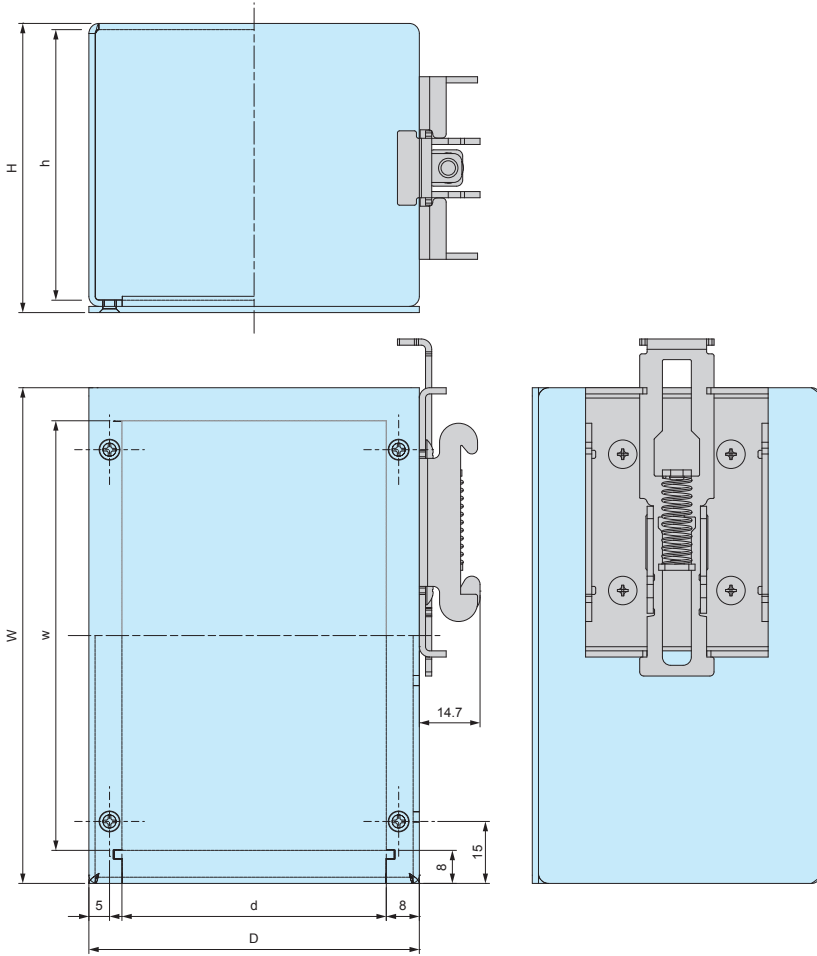

Power supply unit



Communication device

Product no. / Details

Product no.	External dimensions			Internal dimensions			Weight (g)
	W	H	D	w	h	d	
DRB12- 5- 8	120	50	80	104	45.5	64	220.5
DRB12- 7- 8	120	70	80	104	65.5	64	253
DRB12-10- 8	120	100	80	104	95.5	64	301
DRB15- 5-10	150	50	100	134	45.5	84	285.5
DRB15- 7-10	150	70	100	134	65.5	84	326
DRB15-10-10	150	100	100	134	95.5	84	386.5

Accessories (Optional parts)



DIN rail FDR series
See page FDR-1



Adhesive standoff AST series
See page 121

FDR SERIES

DIN-RAIL

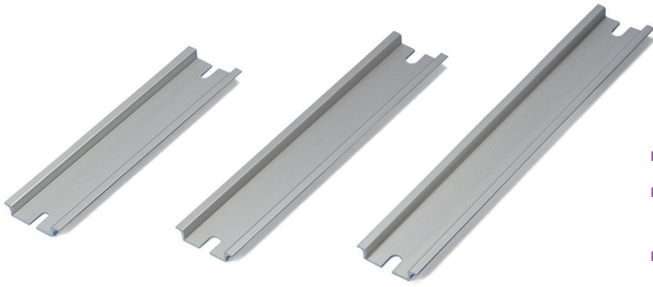

- DIN rail for installation of terminals, relays or switches inside enclosures.
- Available in different models and lengths to fit a wide variety of mounting boss pitch.
- FDR-1000 is available if customized length is required.

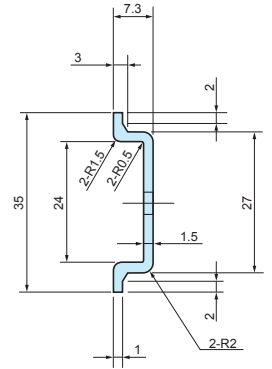
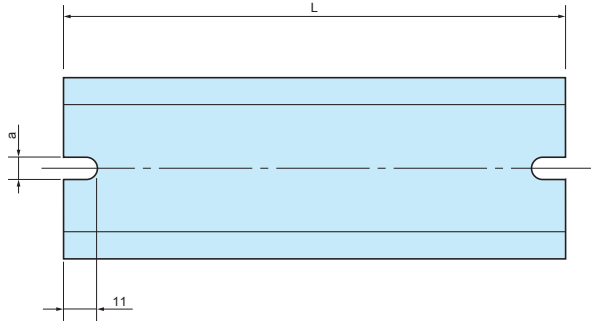
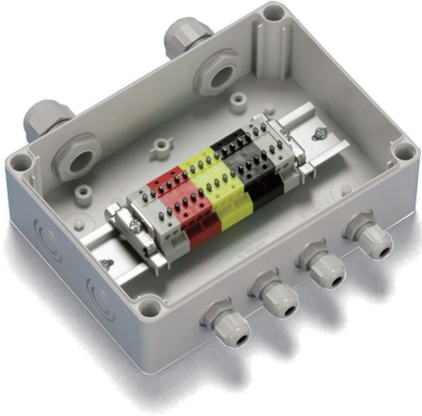

Feature

Material	Finish
Extruded Aluminium A6063S-T5	Silver anodized

Product no. / Dimensions

Product no.	L	a	Matching boss pitch
FDR- 50	50	4.2	32 ~ 42
57	57	4.2	39 ~ 49
66	66	4.2	48 ~ 58
77	77	4.2	59 ~ 69
80	80	4.2	62 ~ 72
87	87	4.2	69 ~ 79
92	92	4.2	74 ~ 84
100	100	4.2	82 ~ 92
106	106	4.2	88 ~ 98
110	110	4.2	92 ~ 102
120	120	4.2	102 ~ 112
128	128	4.2	110 ~ 120
137	137	4.2	119 ~ 129
142	142	4.2	124 ~ 134
146	146	4.2	128 ~ 138
150	150	4.2	132 ~ 142
168	168	4.2	150 ~ 160
170	170	4.2	152 ~ 162
186	186	4.2	168 ~ 178
202	202	4.2	184 ~ 194
205	205	4.2	187 ~ 197
223	223	4.2	205 ~ 215
226	226	4.2	208 ~ 218
235	235	4.2	217 ~ 227
242	242	4.2	224 ~ 234
249	249	4.2	231 ~ 241
283	283	4.2	265 ~ 275
300	300	4.2	282 ~ 292
350	350	4.2	332 ~ 342
450	450	4.2	432 ~ 442
550	550	4.2	532 ~ 542

Product no.	L	a	Matching boss pitch
FDR-B102	102	6.5	86 ~ 92
NEW B124	124	6.5	108 ~ 114
B142	142	6.5	126 ~ 132
B160	160	6.5	144 ~ 150
B165	165	6.5	149 ~ 155
B176	176	6.5	160 ~ 166
B183	183	6.5	167 ~ 173
B223	223	6.5	207 ~ 213
B260	260	6.5	244 ~ 250
B283	283	6.5	267 ~ 273
B303	303	6.5	287 ~ 293
B338	338	6.5	322 ~ 328
B360	360	6.5	344 ~ 350
B376	376	6.5	360 ~ 366
B383	383	6.5	367 ~ 373
B463	463	6.5	447 ~ 453
B560	560	6.5	544 ~ 550
B623	623	6.5	607 ~ 613
FDR-1000	1000	—	—

■ FDR-1000 does not have mounting holes.

AST series

INSERT NUT ADHESIVE STANDOFF



- Double-sided adhesive tape allows the standoff to be mounted quickly and easily; allows PCB mounting in non-boss enclosures.
- Convenient for installing PCBs into enclosures without the need for customization.
- Please ensure that surface is cleaned and grease-free before adhering.
- Once removed, it cannot be adhered on again.

AST dimensions

■ DXF/DWG/PDF/STP drawings available on our website.

AST2.5-□

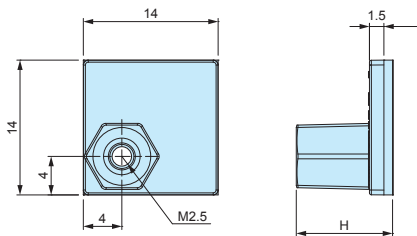

AST3-□

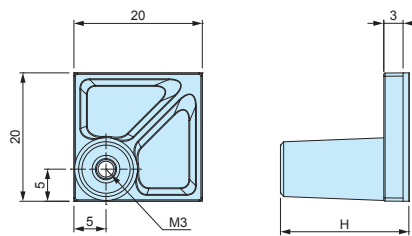

AST4-□

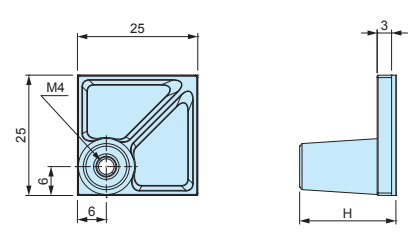

Product no. / Dimensions

Bulk package

Product no	H dimension	Included screw	Recommended PCB Thickness (mm)	Recommended torque (N · m)	Weight (g)	Pack of	Product no	Pack of
AST2.5-5B	5	M2.5-5 pan head	1.0 ~ 2.0	0.3	0.6 (1 piece)	4	AST2.5-5B-P	100
AST2.5-10B	10	M2.5-5 pan head	1.0 ~ 2.0	0.3	0.8 (1 piece)	4	AST2.5-10B-P	100
AST3-6B	6	M3-6 pan head	1.0 ~ 3.0	0.4	1.5 (1 piece)	4	AST3-6B-P	100
AST3-10B	10	M3-6 pan head	1.0 ~ 3.0	0.4	1.6 (1 piece)	4	AST3-10B-P	100
AST3-15B	15	M3-6 pan head	1.0 ~ 3.0	0.4	1.8 (1 piece)	4	AST3-15B-P	100
AST3-20B	20	M3-6 pan head	1.0 ~ 3.0	0.4	2.1 (1 piece)	4	AST3-20B-P	100
AST4-10.5B	10.5	M4-8 pan head	1.0 ~ 3.5	0.8	2.6 (1 piece)	4	AST4-10.5B-P	50
AST4-20B	20	M4-8 pan head	1.0 ~ 3.5	0.8	3.2 (1 piece)	4	AST4-20B-P	50

- Base material / color : Nylon 66 (UL94V-2) / Black
- Nut + screw material / finish : Steel / Trivalent chromate

- Bulk packaging is available. See "Bulk package" column above.
- Screws are not included for bulk packages.

ASR series

ADHESIVE PCB STANDOFF

ASR dimensions

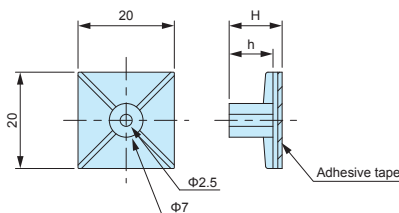

■ DXF/DWG/PDF drawings available on our website.

Technical Data
Recommended torque : 0.4N · m

- M3 tapping screw use adhesive standoff. Recommended to be used with EM-3 or EM-3-6 self-tapping screws (See page 123).
- Please ensure that surface is cleaned and grease-free before adhering.
- Once removed, it cannot be adhered on again.

Product no. / Dimensions

Product no	H	h	Weight (g)	Pack of
ASR- 5	5.1	3.1	0.9 (1 piece)	10
ASR- 6	6.4	4.4	1.0 (1 piece)	10
ASR- 7	7.2	5.1	0.9 (1 piece)	10
ASR- 8	8.1	6.3	0.9 (1 piece)	10
ASR- 9	9	7	1.0 (1 piece)	10
ASR-11	11	9	1.0 (1 piece)	10
ASR-13	12.7	10.7	1.2 (1 piece)	10
ASR-14.5	14.7	12.8	1.1 (1 piece)	10
ASR-16	15.9	13.9	1.3 (1 piece)	10
ASR-19	19.1	17.1	1.4 (1 piece)	10