

- Extruded aluminium corner pillars enables the structure to be rigid when screwed.
- Adjustable sizes available in 1mm intervals, with W and D dimensions from 50 ~ 500mm, and H dimension from 30 ~ 500mm.
- Rubber feet can be provided if required in S (Φ11.2mm) or L (Φ15.7mm) sizes.

■ **Caution**

- On larger sized cases, the top cover may come loose if the middle part is held without support.



Components

No.	Part name	Pcs	Material	Color / Finish
1	Top • Bottom cover	1 each	Aluminium A1100P	Silver anodized
2	W panel	2	Aluminium A1100P	Silver anodized
3	D panel	2	Aluminium A1100P	Silver anodized
4	Pillar	4	Extruded aluminium A6063S-T5	Silver anodized
5	Screw (Hexagonal countersunk - M3 or M4)	8	Stainless steel	Unfinished
6	Rubber feet	0 or 5	Polyurethane	Black

■ Hexagonal wrench included.

1 Specify Dimensions

Specify dimensions in 1mm intervals.

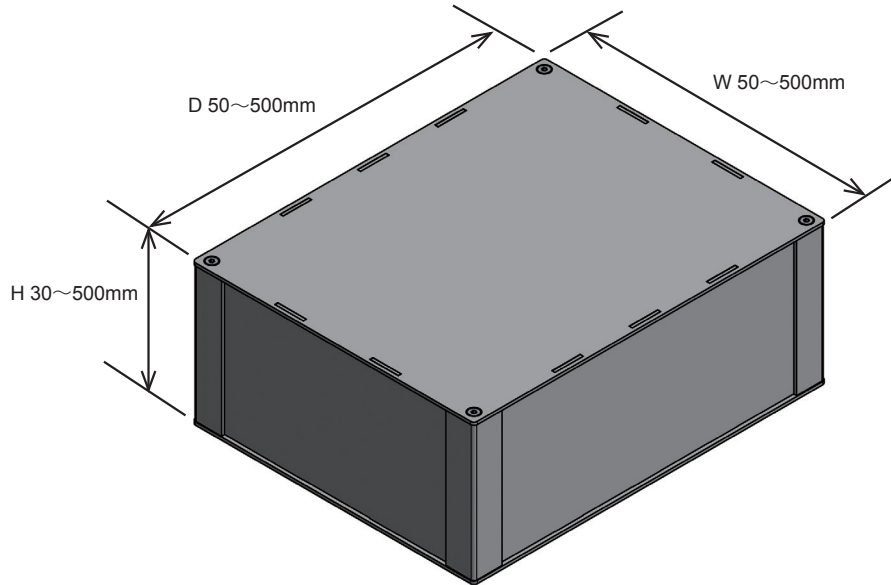

■ Panel thickness, screw sizes, and pillar types vary by W / D dimensions.

[K15] Type

Dimension : refer to chart
 Panel thickness : t = 1.5mm
 Screw size : M3
 Pillar : 15 x 15mm

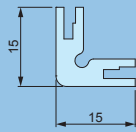

[K20] Type

Dimension : refer to chart
 Panel thickness : t = 2.0mm
 Screw size : M4
 Pillar : 20 x 20mm

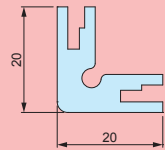

2 Select Rubber feet

Code	A	B	H	Pack of
N (None)	—	—	—	—
S	12.7	9.5	3	5
L	20.6	12.7	7.6	5

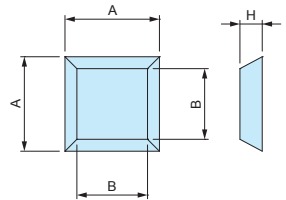

Confirm Product No.

Confirm an assigned product number in the following order format as below.

Product no. ALSF

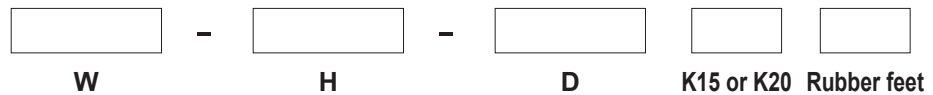

Example : W = 300 mm, H = 350 mm, D = 400 mm with L type rubber feet.

ALSF [300] - [350] - [400] [K20] [L]

Lead time

Custom Size Only 8 business days (1 ~ 3 pcs)
 Custom Size + Hole Milling 9 business days (1 ~ 3 pcs)

Order Inquiry

For more information, contact us here at sales@takachi-el.co.jp

ALSF Type Chart

Refer to the below chart for K15 or K20 type selection by W & D dimensions.

[K15] Type : t = 1.5mm • M3 screw • 15 x 15 pillar

[K20] Type : t = 2.0mm • M4 screw • 20 x 20 pillar

W	H	D												
			50~100	101~150	151~200	201~250	251~300	301~350	351~400	401~450	451~500			
50~100	30~100													
	101~200													
	201~300													
	301~400													
	401~500													
101~150	30~100													
	101~200													
	201~300													
	301~400													
	401~500													
151~200	30~100													
	101~200													
	201~300													
	301~400													
	401~500													
201~250	30~100													
	101~200													
	201~300													
	301~400													
	401~500													
251~300	30~100													
	101~200													
	201~300													
	301~400													
	401~500													
301~350	30~100													
	101~200													
	201~300													
	301~400													
	401~500													
351~400	30~100													
	101~200													
	201~300													
	301~400													
	401~500													
401~450	30~100													
	101~200													
	201~300													
	301~400													
	401~500													
451~500	30~100													
	101~200													
	201~300													
	301~400													
	401~500													

[K15] type

[K20] type

ALSF dimensions

[K15] type : t = 1.5 mm • Screw size : M3 • Pillar : 15 x 15 mm

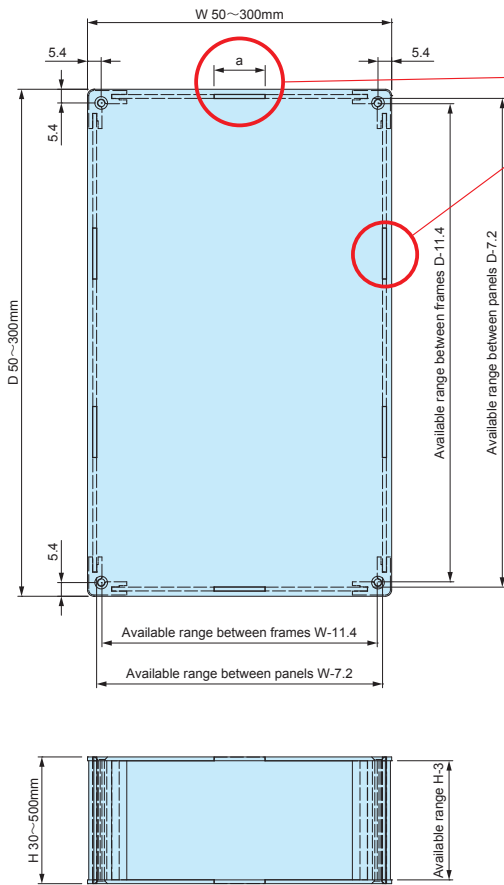

Number of joints vary by specified W / D dimensions.
Refer to the below chart for more information.

W dimension	Joint a dimension	Number of Joints (one side)
50~100	10mm	1
101~150	20mm	1
151~200	20mm	2
201~300	20mm	3

D dimension	Joint a dimension	Number of Joints (one side)
50~100	10mm	1
101~150	20mm	1
151~200	20mm	2
201~300	20mm	3

[K20] type : t = 2.0 mm • Screw size : M4 • Pillar : 20 x 20 mm

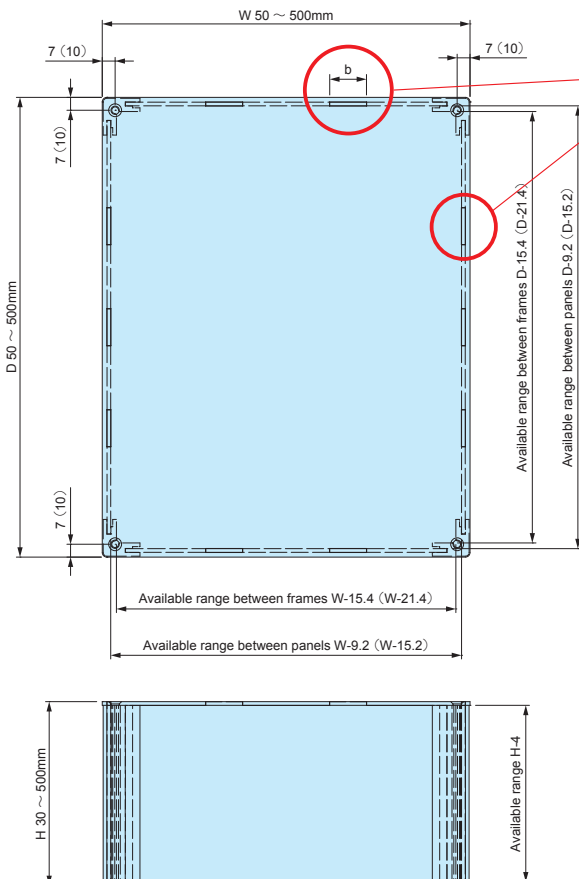

Number of joints vary by specified W / D dimensions.
Refer to the below chart for more information.

W dimension	Joint a dimension	Number of Joints (one side)
50~100	10mm	1
101~150	20mm	1
151~200	20mm	2
201~300	20mm	3
301~400	20mm	4
401~500	20mm	5

D dimension	Joint a dimension	Number of Joints (one side)
50~100	10mm	1
101~150	20mm	1
151~200	20mm	2
201~300	20mm	3
301~400	20mm	4
401~500	20mm	5

※ Available range values within () is applicable if D / W dimension is 301mm or larger.