

# 外視 / External View

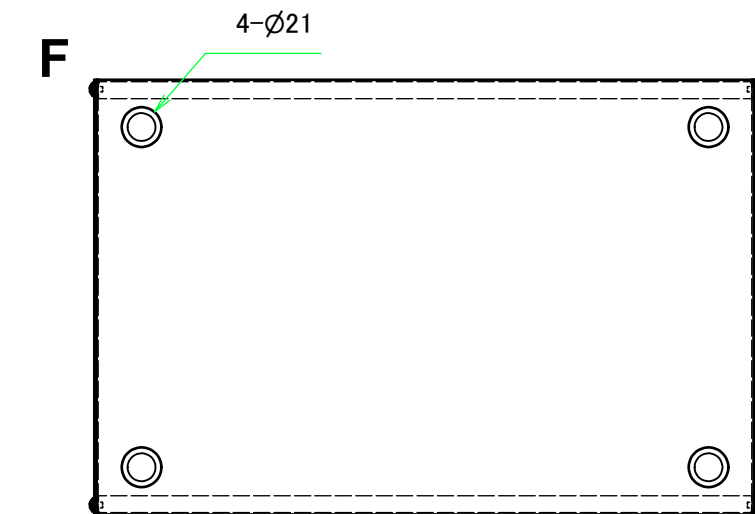

貼付ゴム足  
(任意の位置に取付できます)  
Adhesive rubber feet

構成内容 / Components				
No.	名称 / Part name	数量 / Pcs	材質 / Material	色・表面処理 / Color・Finish
1	カバー Cover	1	アルミ板 A1100P t1.0 Aluminium A1100P t1.0	シルバーアルマイト Silver anodized
2	シャーシ Base	1	アルミ板 A1100P t1.0 Aluminium A1100P t1.0	ブラック・塗装 Black・Painted
3	取付ビス(トラスM3 x 5) Screw(Truss head M3 - 5)	4	真ちゆう Brass	ニッケルメッキ Nickel plated
4	ワッシャー(M3用) Washer(M3)	4	真ちゆう Brass	ニッケルメッキ Nickel plated
5	ゴム足 / Rubber feet	4	合成ゴム / Rubber	ブラック / Black

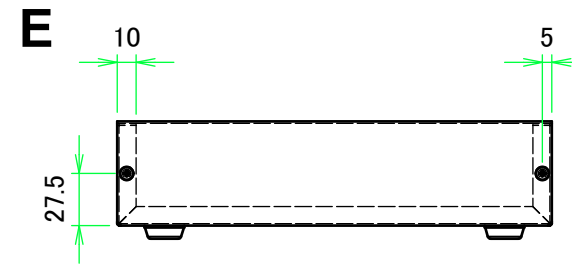
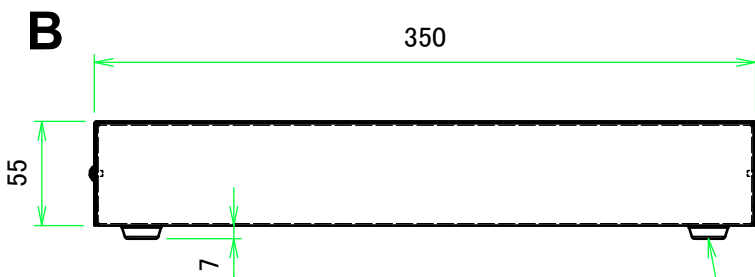
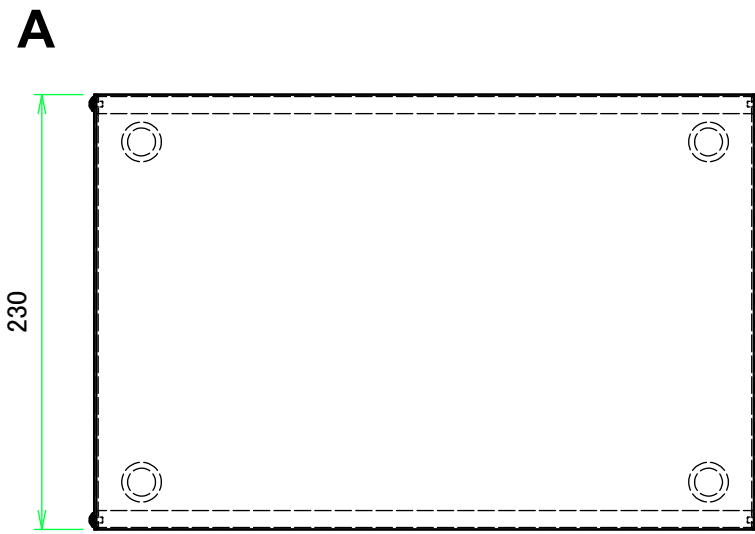
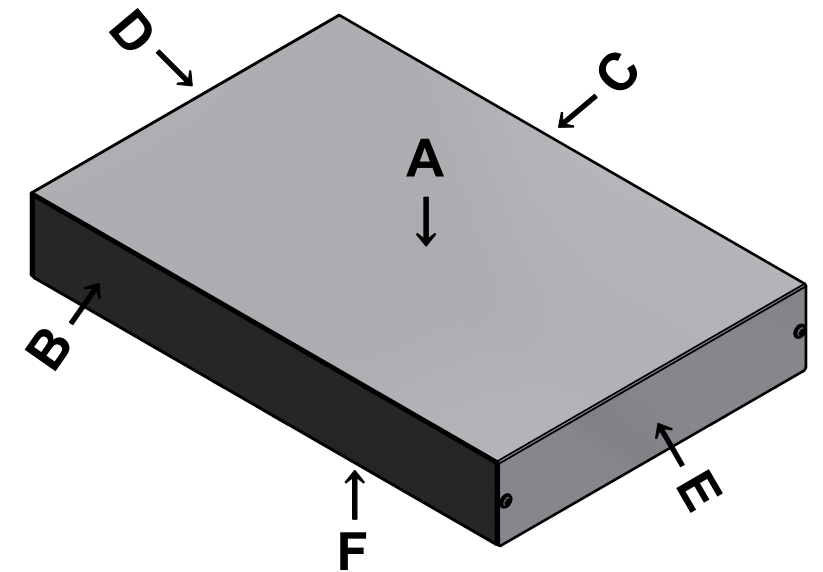
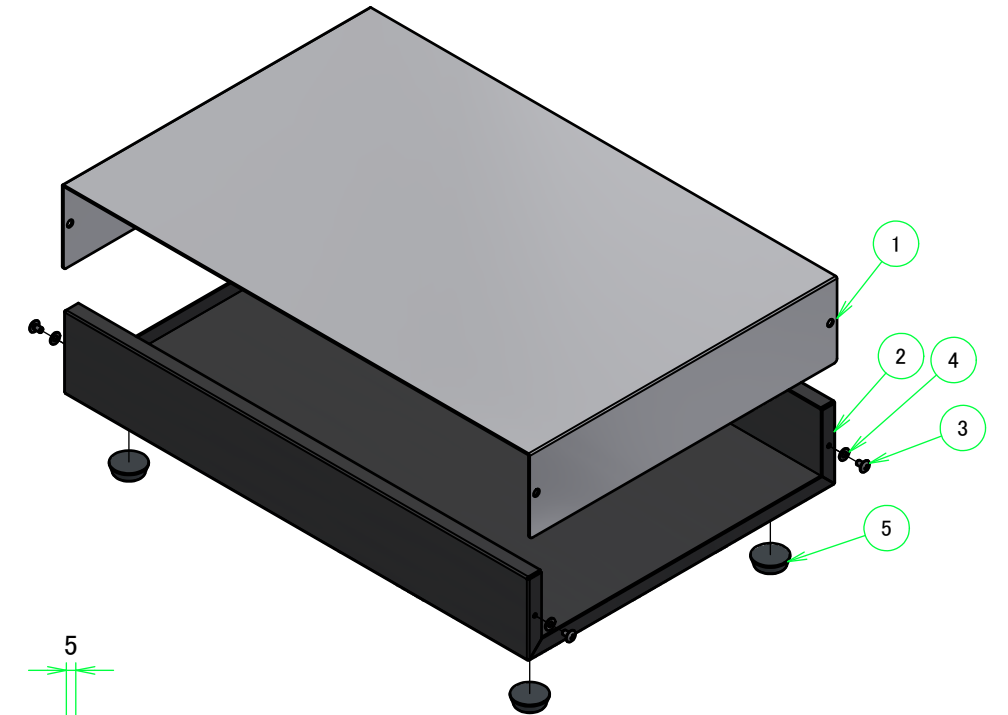

株式会社タカチ電機工業 TAKACHI ELECTRONICS ENCLOSURE CO., LTD.			品名/Title 薄型アルミケース FLAT ALUMINIUM CASE	尺度/Scale 1:4
承認/Approved 中根	検図/Checked 大江	製図/Created 横田	型番/Product number YM-350 作成日/Date 2022/05/02	
				1 / 3

カバー / Cover

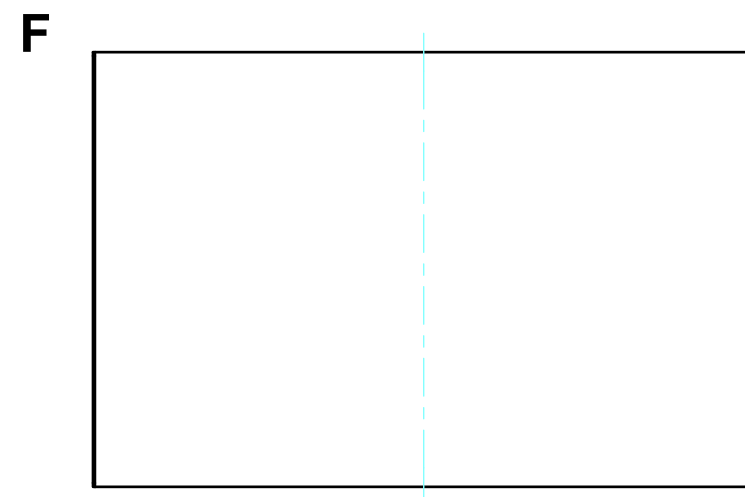
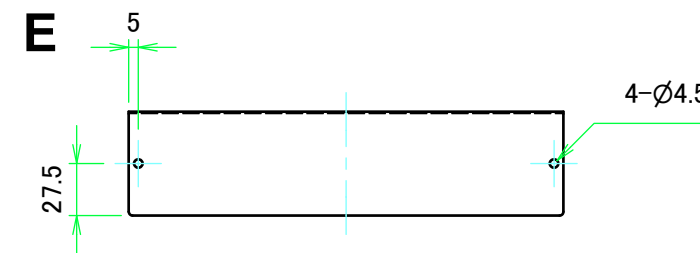
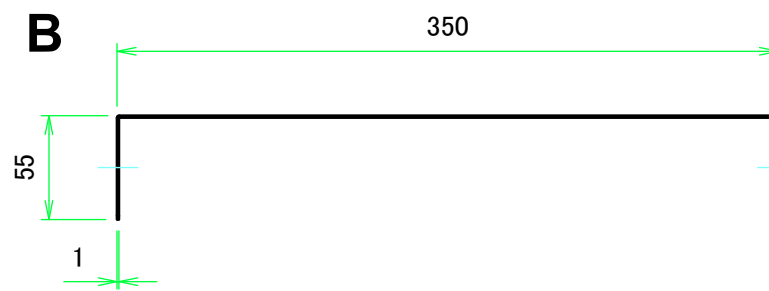
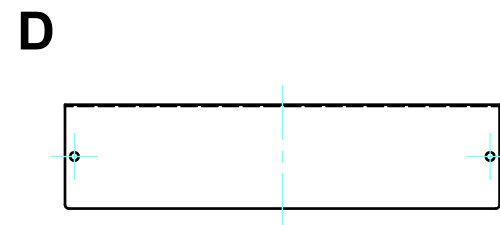
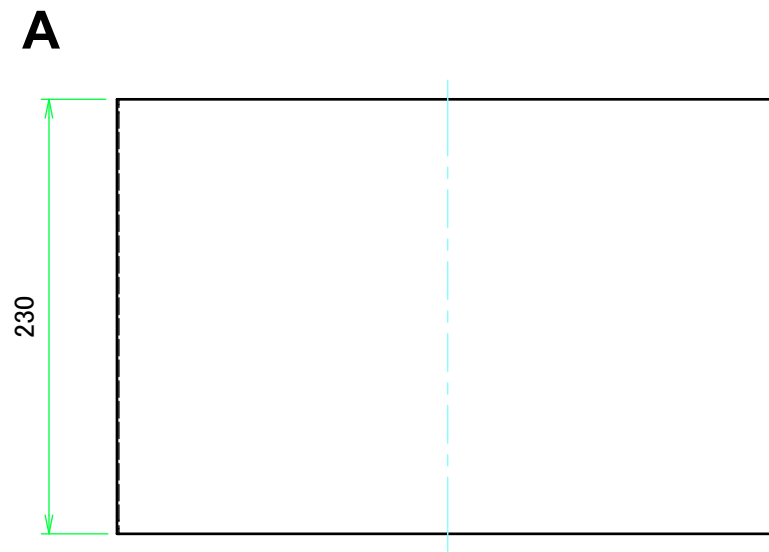

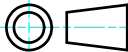
 株式会社タカチ電機工業 TAKACHI ELECTRONICS ENCLOSURE CO., LTD.			品名/Title 薄型アルミケース FLAT ALUMINIUM CASE	 尺度/Scale 1:4
承認/Approved 中根	検図/Checked 大江	製図/Created 横田	型番/Product number YM-350	
			作成日/Date 2022/05/02	2 / 3

シャーシ / Base

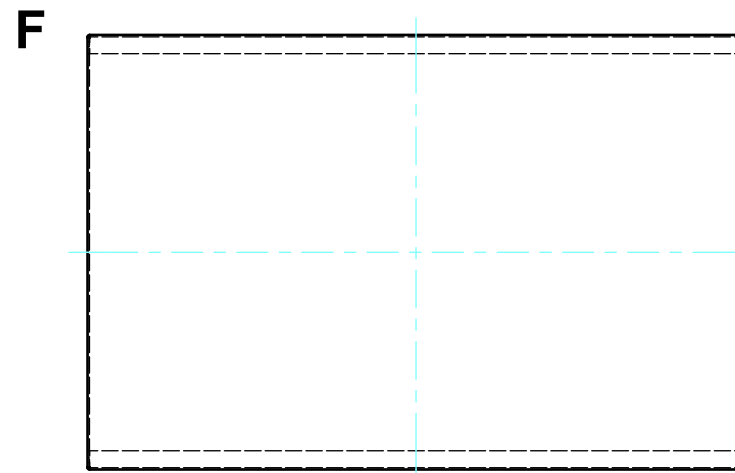
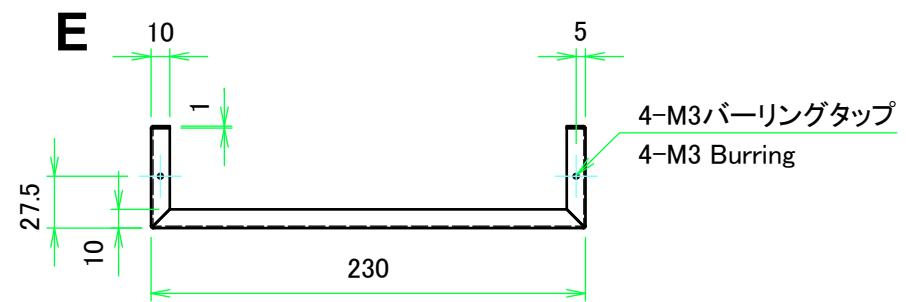
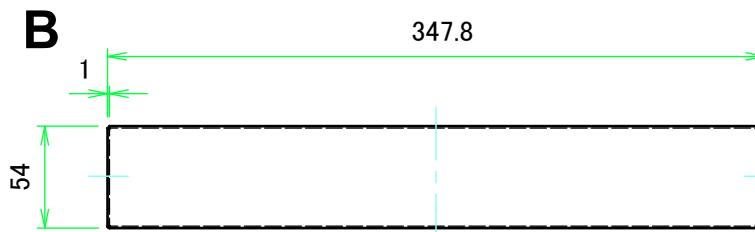
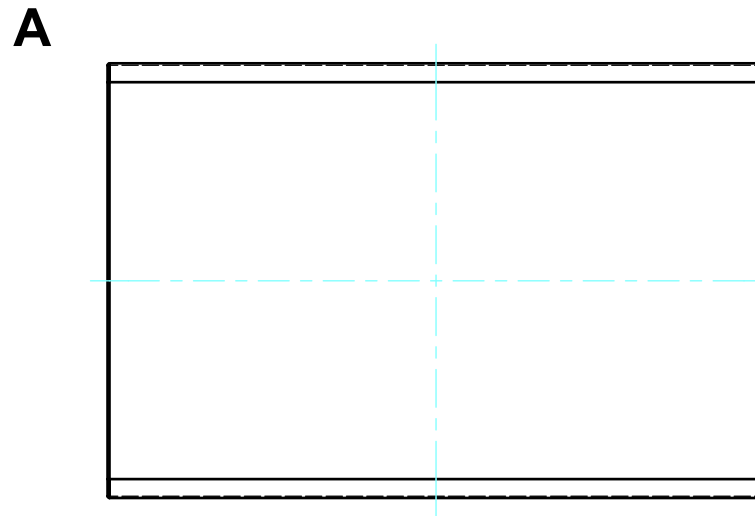
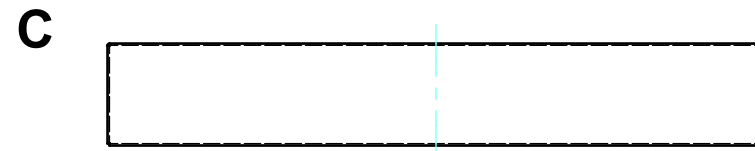

株式会社タカチ電機工業 TAKACHI ELECTRONICS ENCLOSURE CO., LTD.		品名/Title 薄型アルミケース FLAT ALUMINIUM CASE	尺度/Scale 1:4
承認/Approved 中根	検図/Checked 大江	製図/Created 横田	
			作成日/Date 2022/05/02
			3 / 3