

取付方法1(シャーシ下5.5mm) / How to fix 1

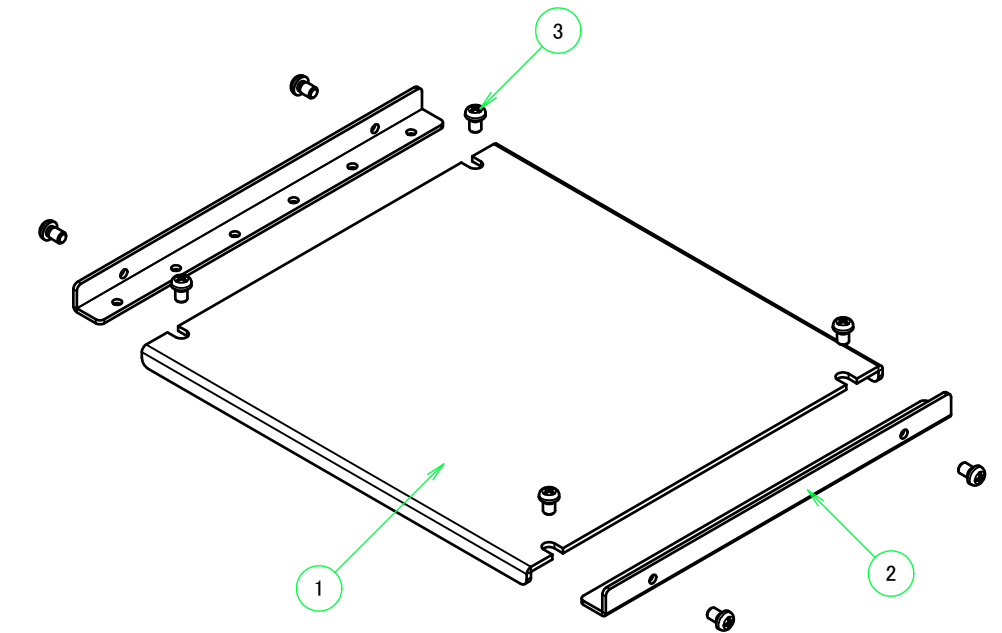

取付方法2(シャーシ下13.1mm) / How to fix 2

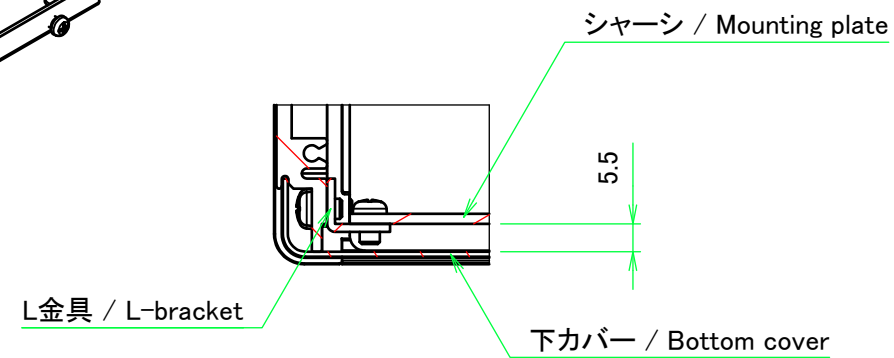
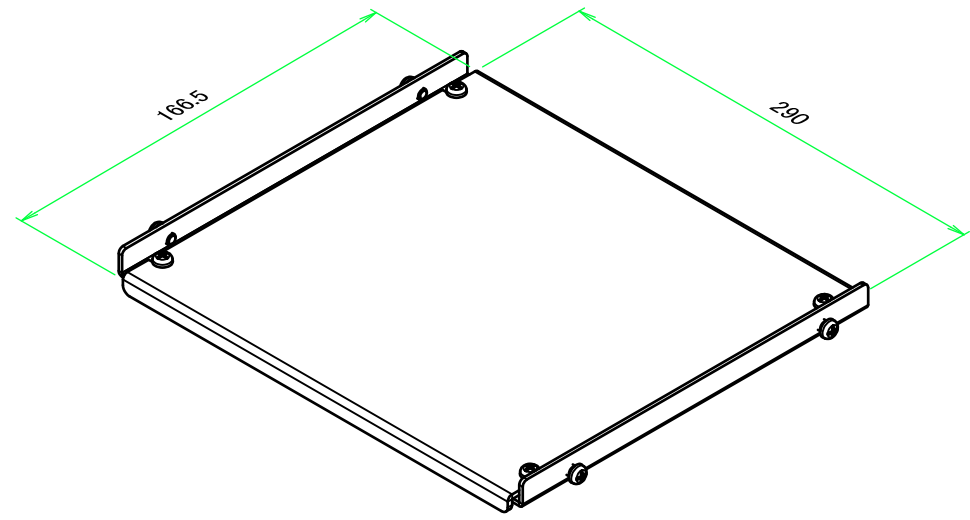
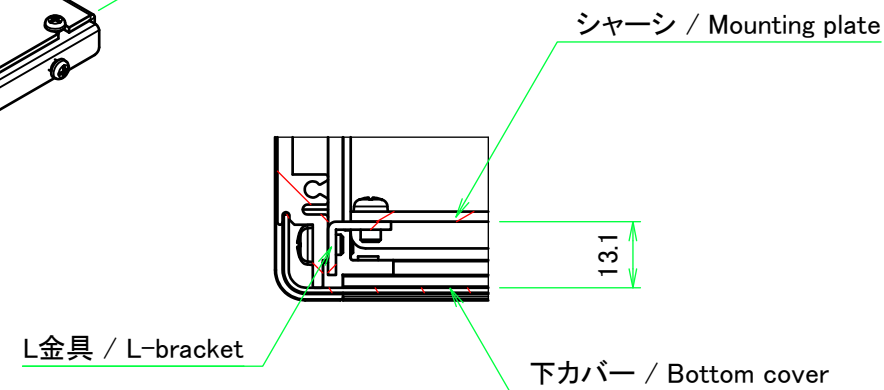
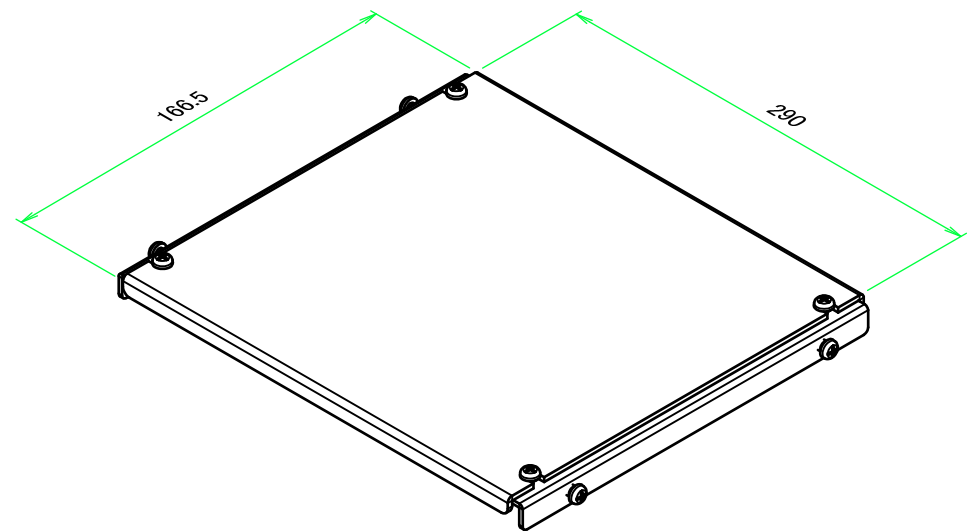

■テクニカルデータ / Technical Data■  
 対応ケース / Suitable case : MS□-32-23 , MO□-32-23

構成内容 / Components				
No.	名称 / Part name	数量 / Pcs	材質 / Material	色・表面処理 / Color・Finish
1	シャーシ Mounting plate	1	アルミ板 A1050P Aluminium A1050P	無処理 Unfinished
2	L金具 L-bracket	2	鋼板 SPCC Steel SPCC	三価クロメート Trivalent chromate
3	取付ビス(M4 x 6 ナベ) Screw (M4 - 6 Pan head)	8	鉄 Steel	三価クロメート Trivalent chromate

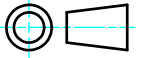
<b>TAKACHI</b> 株式会社タカチ電機工業 TAKACHI ELECTRONICS ENCLOSURE CO., LTD.		品名/Title シャーシ MOUNTING PLATE		 尺度/Scale
承認/Approved	検図/Checked	製図/Created	型番/Product number MSC32-23	
	王	野村	作成日/Date 2017/12/08	1 / 2

シャーシ / Mounting plate

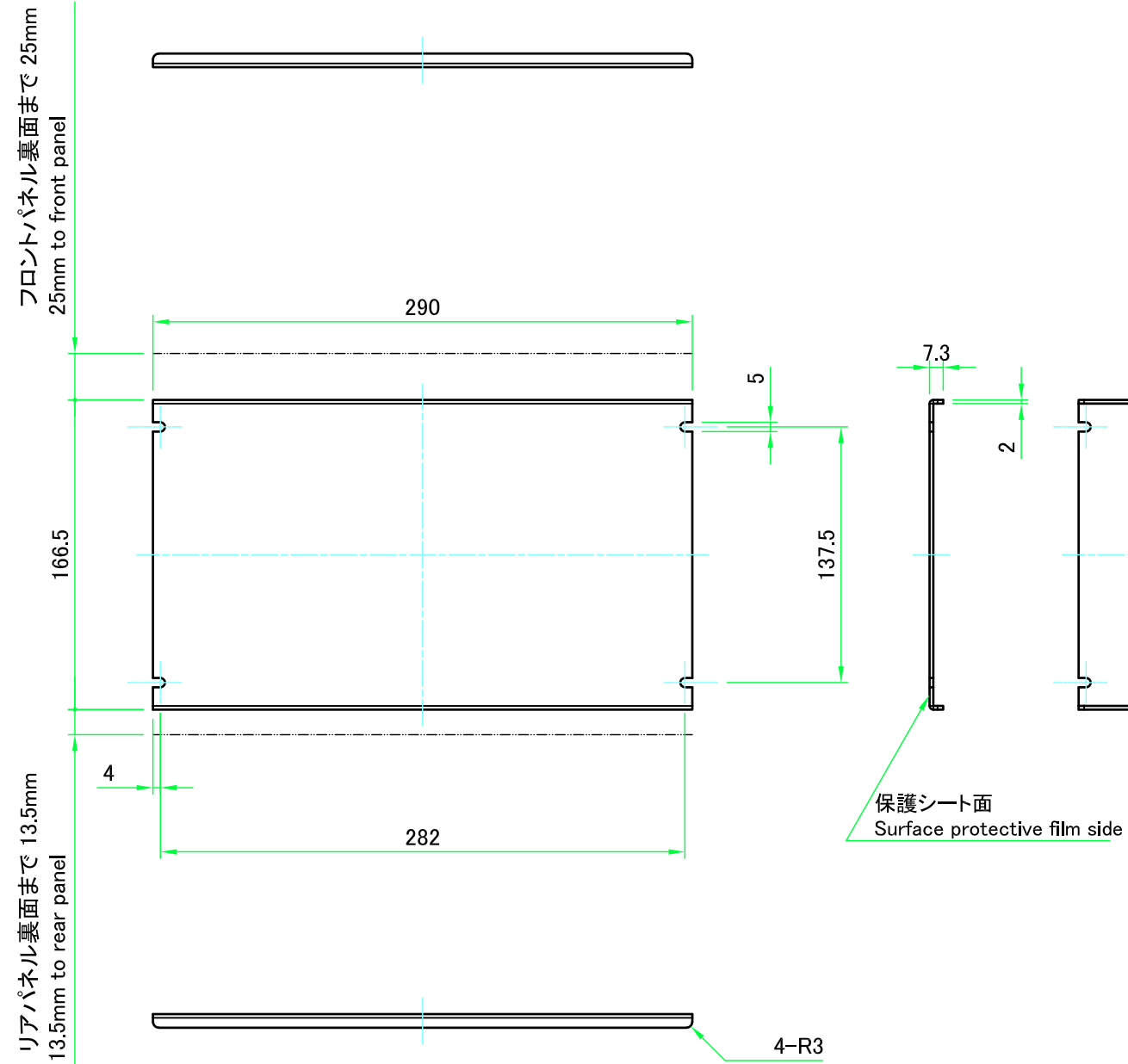

L型取付金具 / L-bracket

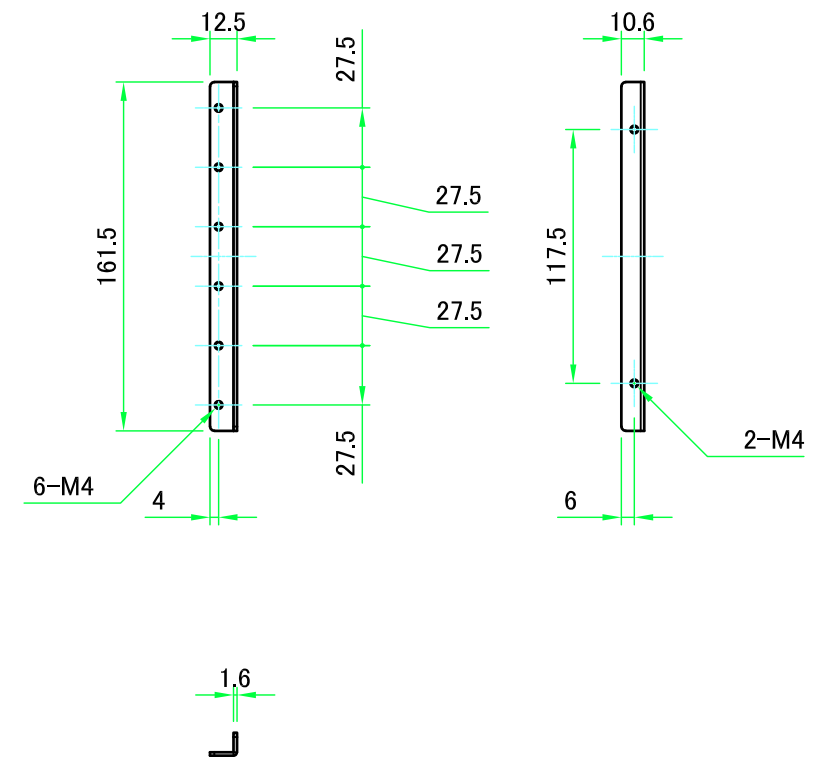

株式会社タカチ電機工業 TAKACHI ELECTRONICS ENCLOSURE CO., LTD.			品名/Title シャーシ MOUNTING PLATE	尺度/Scale 1:3.5
承認/Approved	検図/Checked	製図/Created	型番/Product number MSC32-23	
	王	野村	作成日/Date 2024/06/12	2 / 2