

外視 / External view

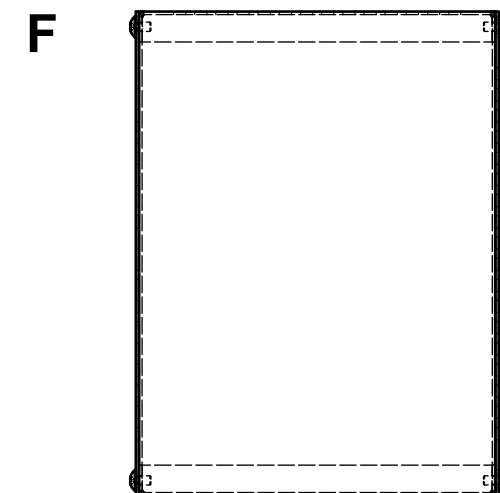

No.	名称	数量	構成内容	
			材質	色・表面処理
1	カバー Cover	1	アルミ板 A1100P t1.0 Aluminium A1100P t1.0	表面 メタリックシルバー塗装, 裏面 導通処理 Metallic silver painted, Inside Conductivefinished
2	シャーシ Base	1	アルミ板 A1100P t1.0 Aluminium A1100P t1.0	表面 メタリックシルバー塗装, 裏面 導通処理 Metallic silver painted, Inside Conductivefinished
3	取付ビス(トラスM3 x 5) Screw(Truss head M3 - 5)	4	鉄 Steel	ニッケルメッキ Nickel Plated

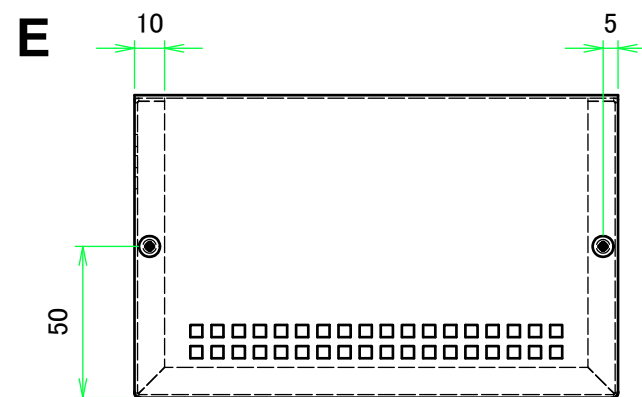
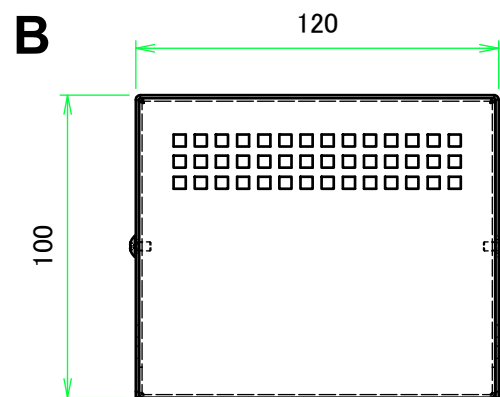
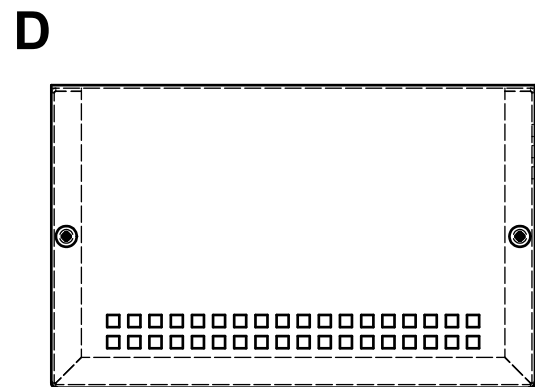
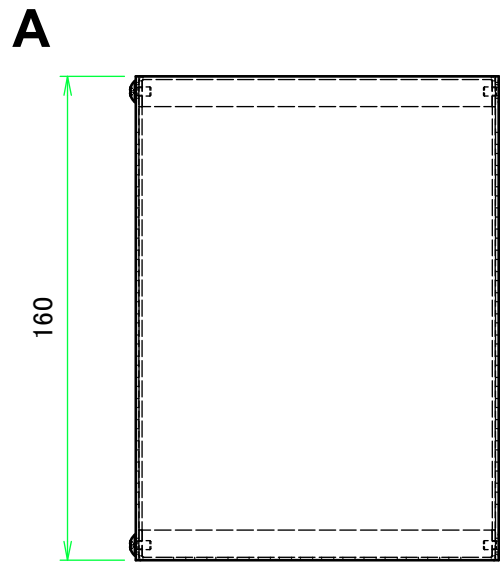
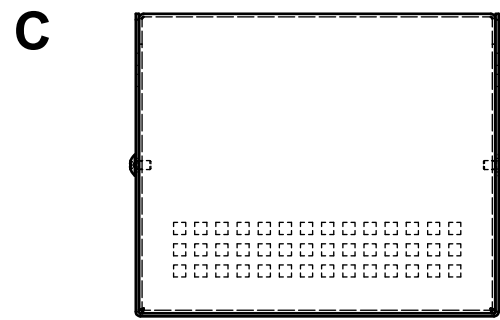
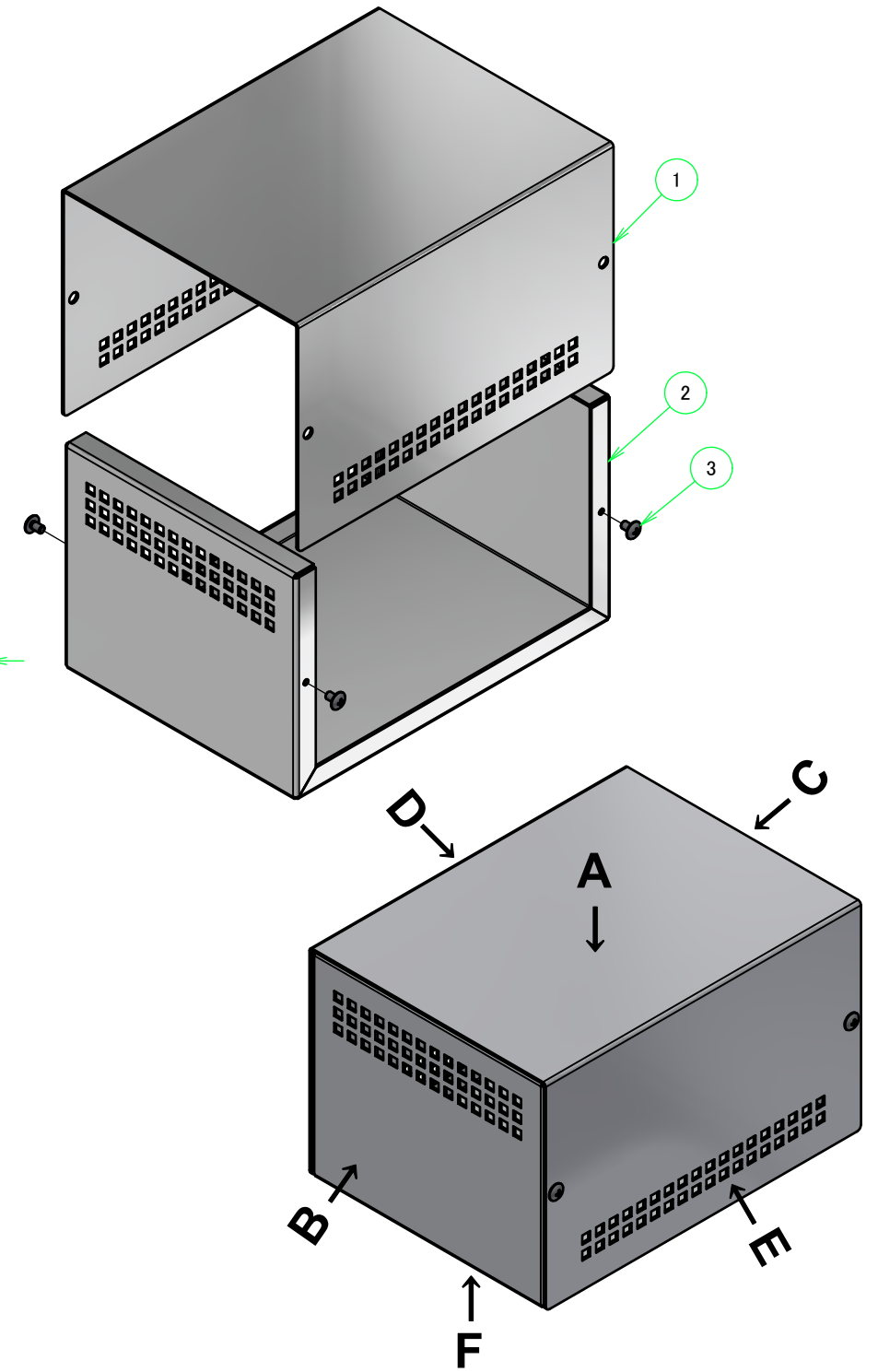

株式会社タカチ電機工業 TAKACHI ELECTRONICS ENCLOSURE CO., LTD.			品名/Title 放熱穴付アルミケース ALUMINIUM CASE WITH VENT HOLES	尺度/Scale 1:2.5
承認/Approved	検図/Checked	製図/Created	型番/Product number MBH12-10-16	
中根	大江	横田	作成日/Date 2022/06/16	1 / 3

カバー / Cover

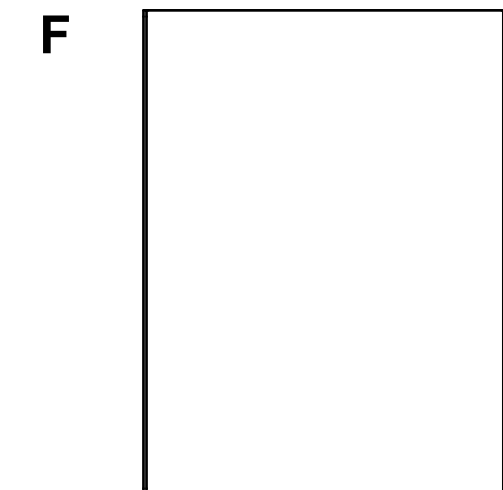
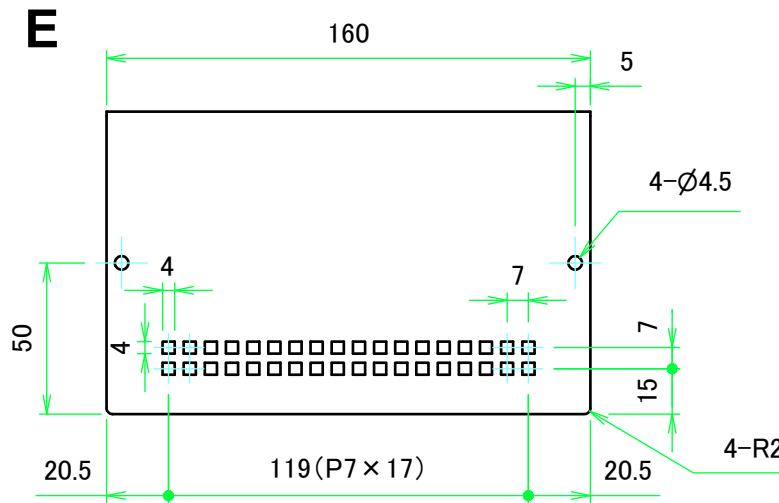
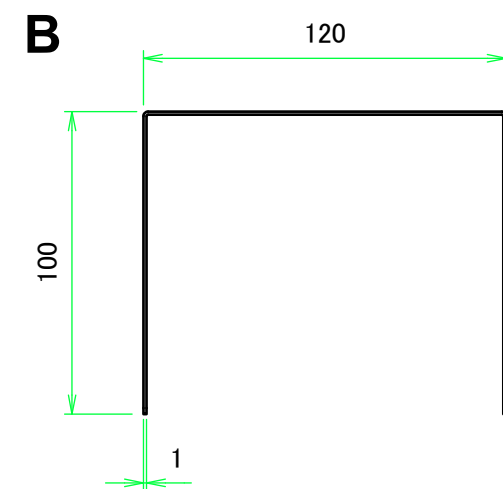
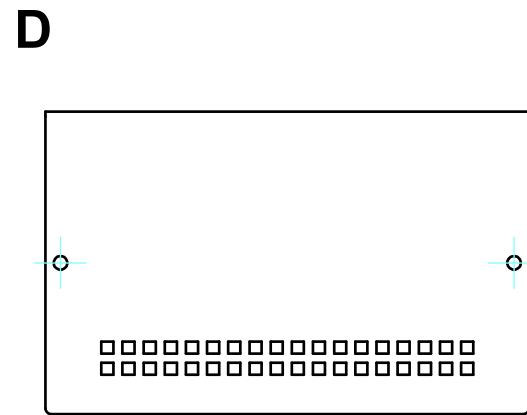
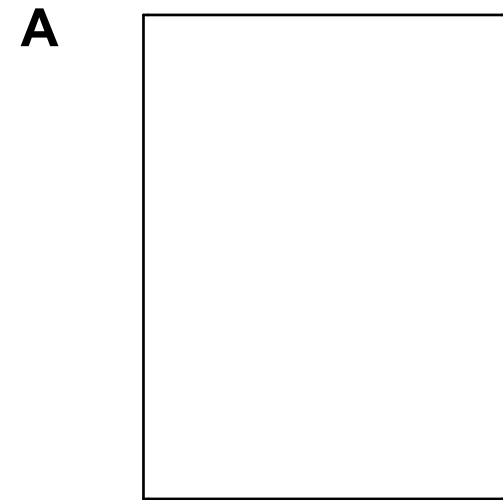
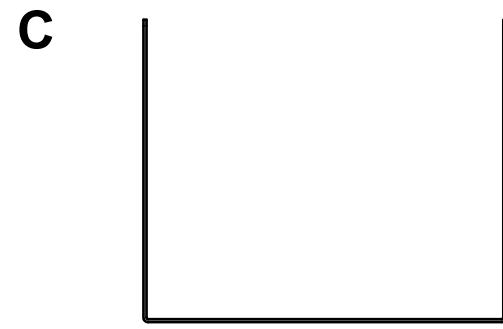

株式会社タカチ電機工業 TAKACHI ELECTRONICS ENCLOSURE CO., LTD.		品名/Title 放熱穴付アルミケース ALUMINIUM CASE WITH VENT HOLES	尺度/Scale 1:2.5
承認/Approved 中根	検図/Checked 大江	製図/Created 横田	
作成日/Date 2022/06/16			2 / 3

シャーシ / Base

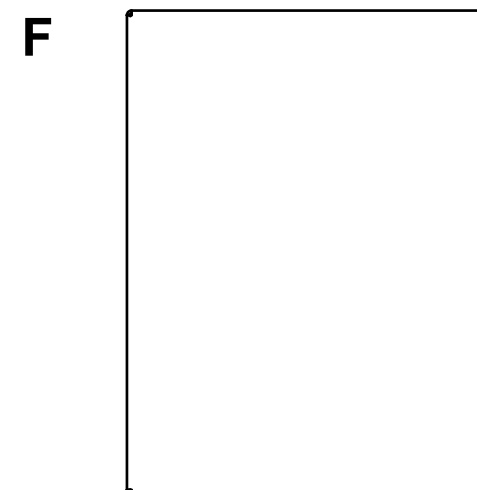
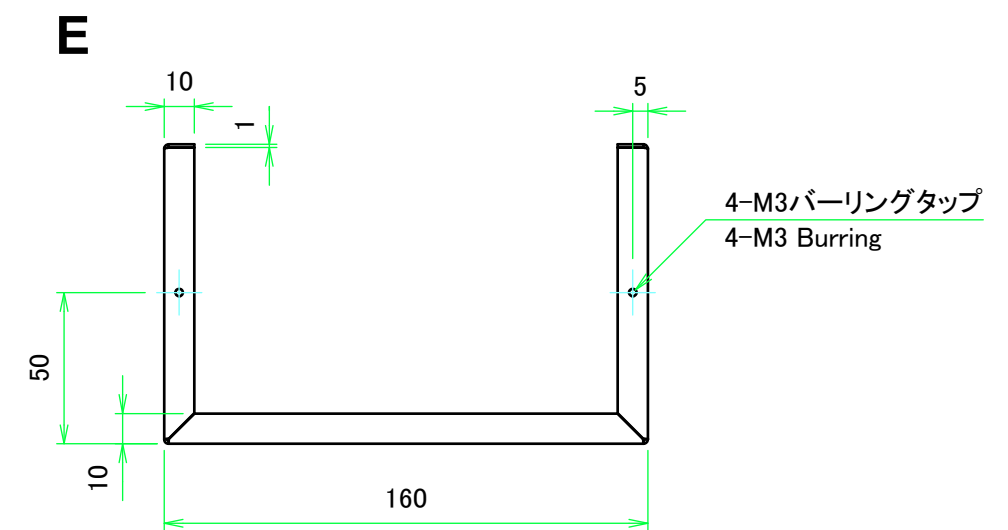
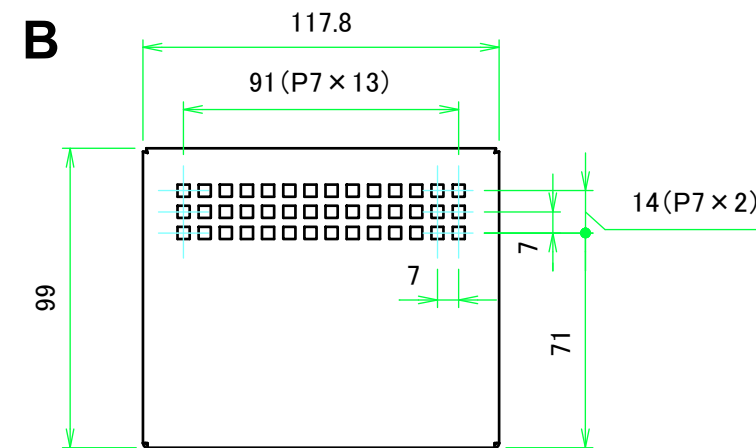
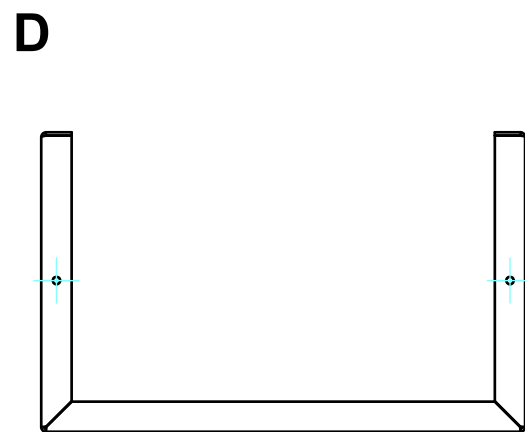
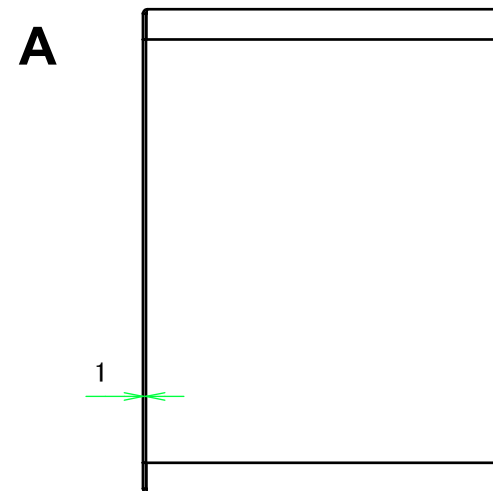
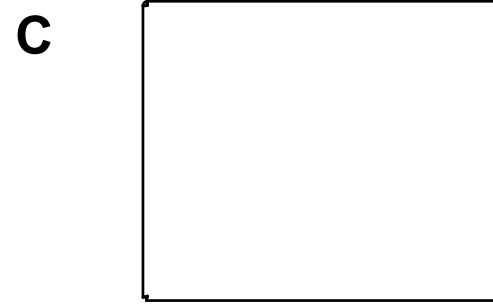

株式会社タカチ電機工業 TAKACHI ELECTRONICS ENCLOSURE CO., LTD.			品名/Title 放熱穴付アルミケース ALUMINIUM CASE WITH VENT HOLES	尺度/Scale 1:2.5
承認/Approved	検図/Checked	製図/Created	型番/Product number MBH12-10-16	
中根	大江	横田	作成日/Date 2022/06/16	3 / 3