

ケース型番 / Product Number

EXHS 187 - 82 - N
 D フランジタイプ 色記号
 No Flange Type Color Code

寸法制限範囲 / Dimension limit range
 D = 40 ~ 500

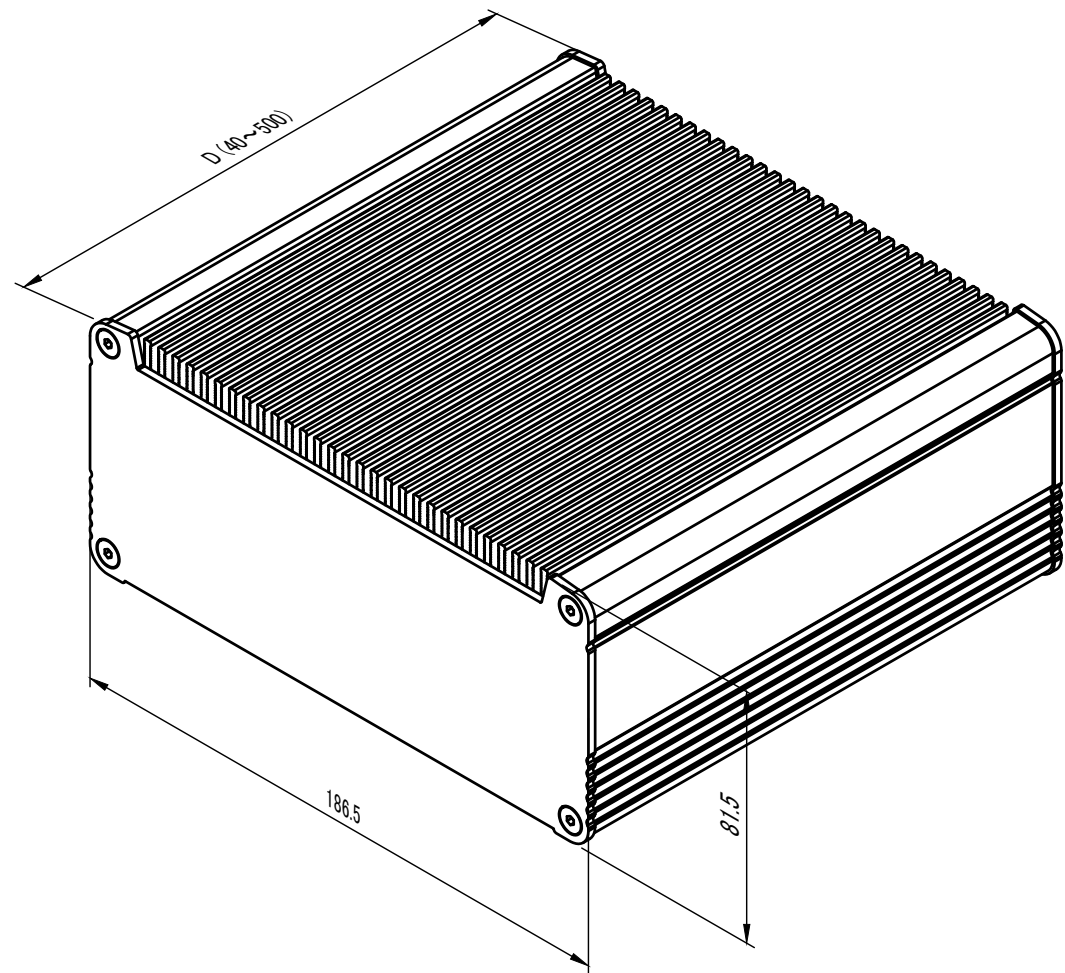

構成内容 / Components				
No.	名称 / Part name	数量 / Pcs	材質 / Material	色・表面処理 / Color・Finish
1	パネル Panel	2	アルミ板 A1050P Aluminium A1050P	メタリックシルバー・表面塗装-裏面無処理,ブラックアルマイト Metallic Silver・Painted (Unfinished inside),Black anodized
2	ヒートシンクカバー Heat-sink top cover	1	アルミ押出材 A6063S-T5 Extruded aluminium A6063S-T5	メタリックシルバー・表面塗装-内面無処理,ブラックアルマイト Metallic Silver・Painted (Unfinished inside),Black anodized
3	下カバー Bottom frame	1	アルミ押出材 A6063S-T5 Extruded aluminium A6063S-T5	メタリックシルバー・表面塗装-内面無処理,ブラックアルマイト Metallic Silver・Painted (Unfinished inside),Black anodized
4	取付ビス(六角穴付皿M4×10) Screw (Hexagonal M4-10)	8	ステンレス Stainless steel	無処理 Unfinished
5	ゴム足 / Rubber feet	4	ポリウレタン / Polyurethane	ブラック / Black

※ゴム足は任意の場所に貼り付けできます。
 ※Adhesive rubber feet included.

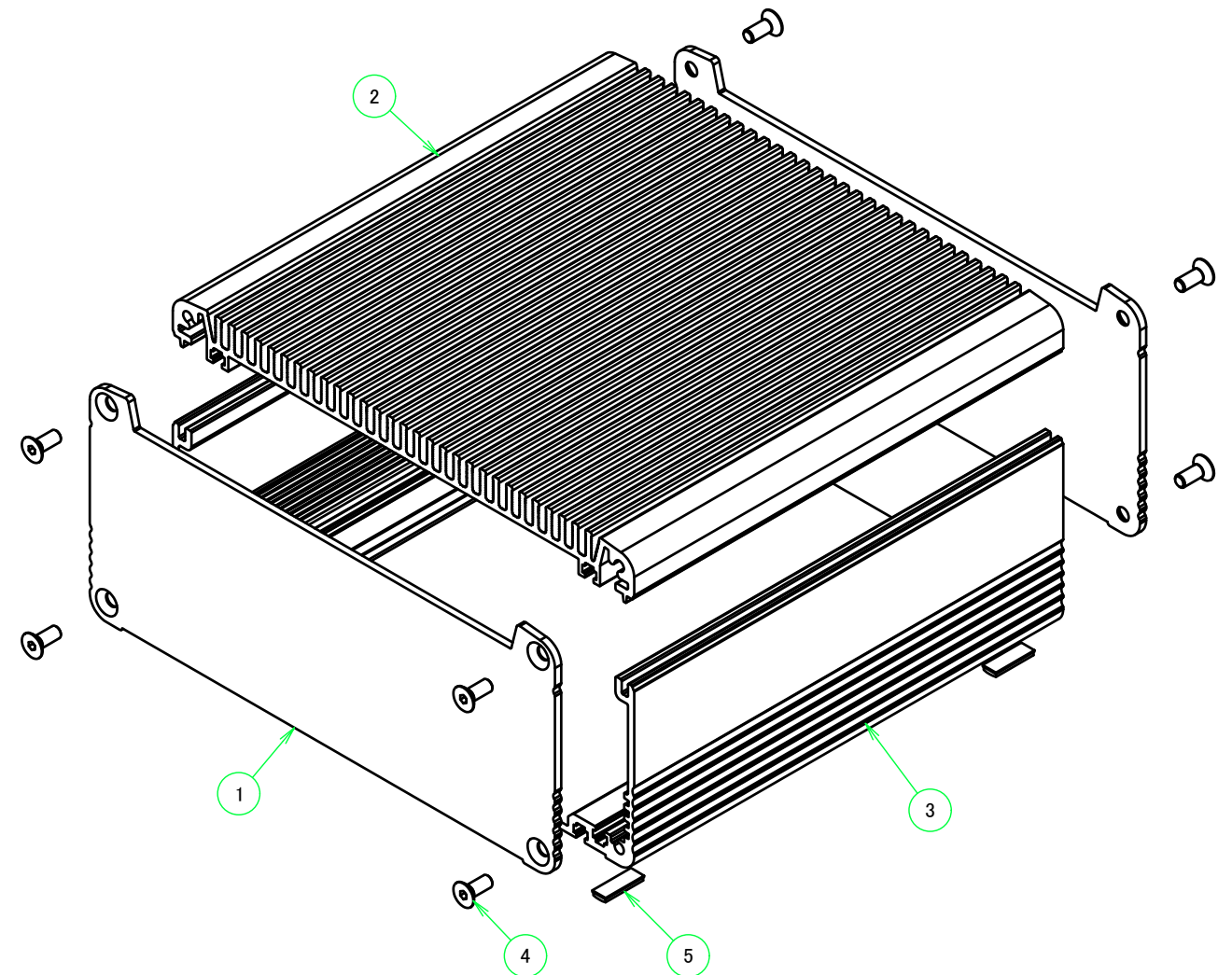

本図面および付帯する部品図の著作権は株式会社タカチ電機工業に帰属します。 / Copyright (C) TAKACHI ELECTRONICS ENCLOSURE CO., LTD. All Rights Reserved.

色仕様(型番末尾口)/Color type		
記号/Code	ヒートシンク・下カバー/Cover	パネル/Panel
S	シルバー/Silver	シルバー/Silver
B	ブラック/Black	ブラック/Black

株式会社タカチ電機工業 TAKACHI ELECTRONICS ENCLOSURE CO., LTD.			品名/Title フリーサイズヒートシンクケース CUSTOM SIZED HEAT-SINK ENCLOSURE	
承認/Approved	検図/Checked	製図/Created	型番/Product number	尺度/Scale
中根	大江	岡本	EXHS187-82- <input type="text"/> N <input type="text"/>	1 : 2
			作成日/Date 2023/03/22	1 / 5

4-M4皿ビス
4-M4 Countersunk

ゴム足
Rubber feet

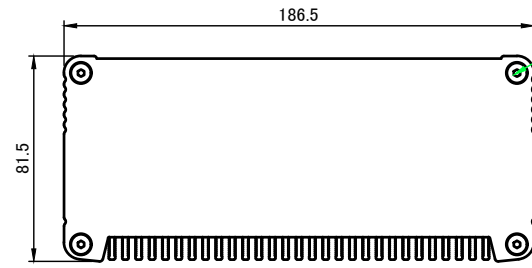
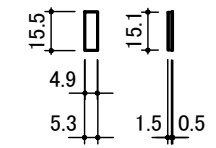

B-B (1:3)

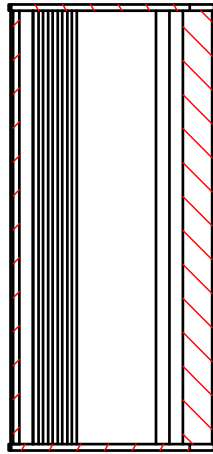

C D

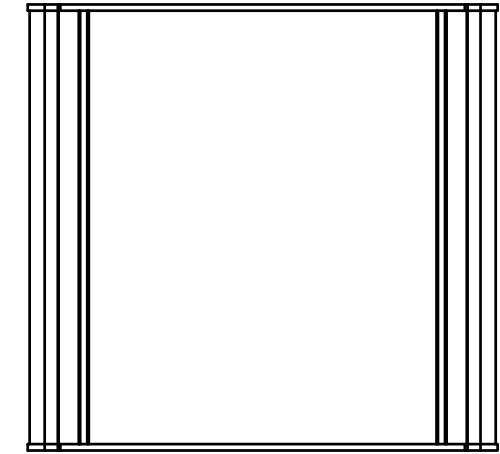
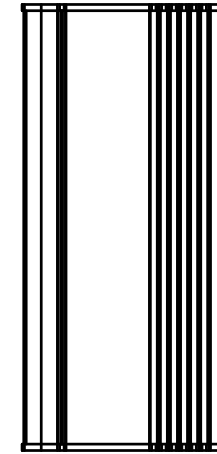
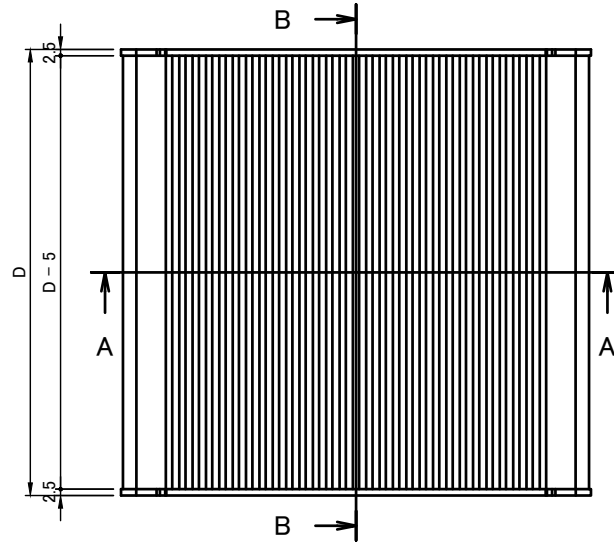
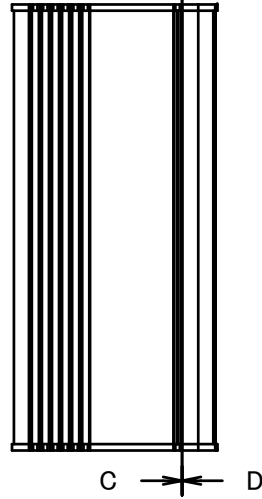

C-C (1:3)

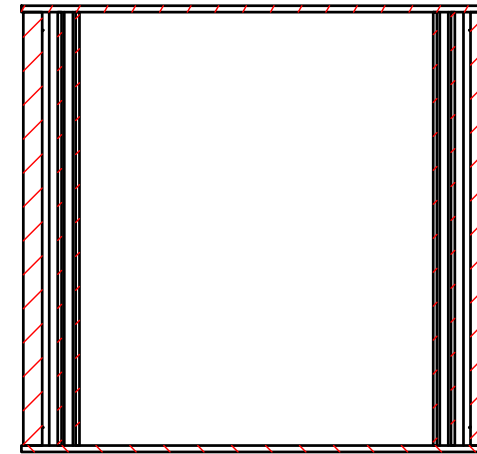

D-D (1:3)

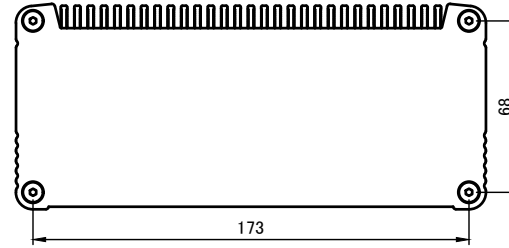
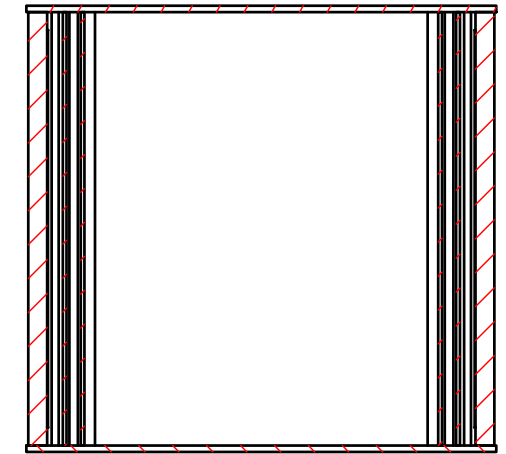

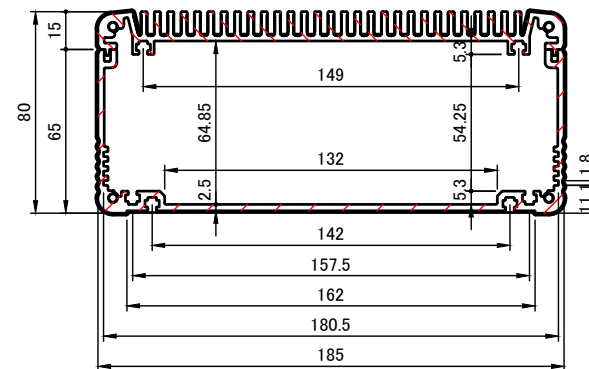

A-A (1:3)

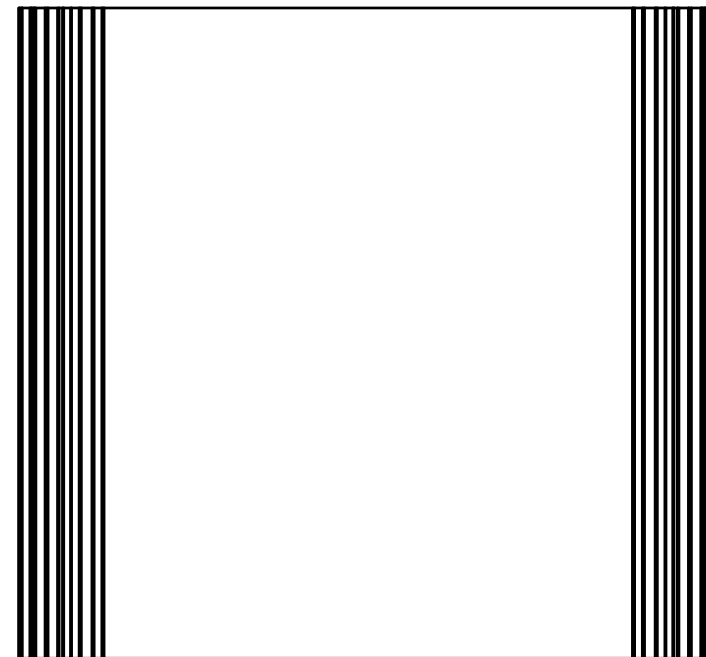
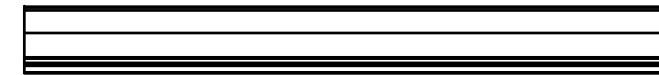
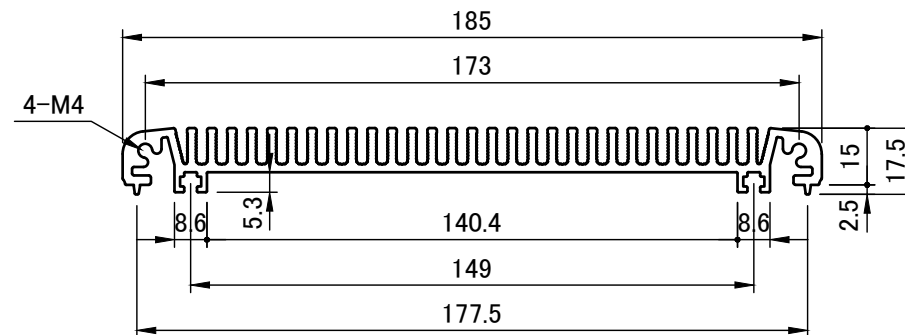
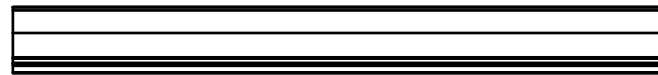
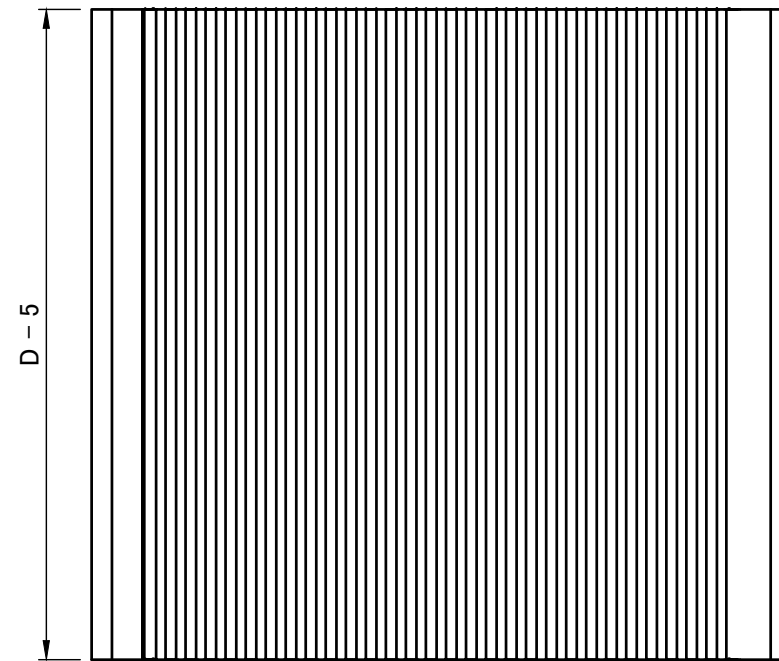

株式会社タカチ電機工業 TAKACHI ELECTRONICS ENCLOSURE CO., LTD.			品名/Title フリーサイズヒートシンクケース CUSTOM SIZED HEAT-SINK ENCLOSURE	尺度/Scale 1:3
承認/Approved	検図/Checked	製図/Created	型番/Product number EXHS187-82-□N□	
中根	大江	岡本	作成日/Date 2022/10/14	2 / 5

ヒートシンクカバー / Heat-sink top cover

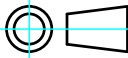

 株式会社タカチ電機工業 TAKACHI ELECTRONICS ENCLOSURE CO., LTD.			品名/Title ヒートシンクカバー HEAT-SINK TOP COVER	
承認/Approved	検図/Checked	製図/Created	型番/Product number W185	尺度/Scale 1 : 2
中根	大江	岡本	作成日/Date 2022/10/14	3 / 5

下カバー / Bottom frame

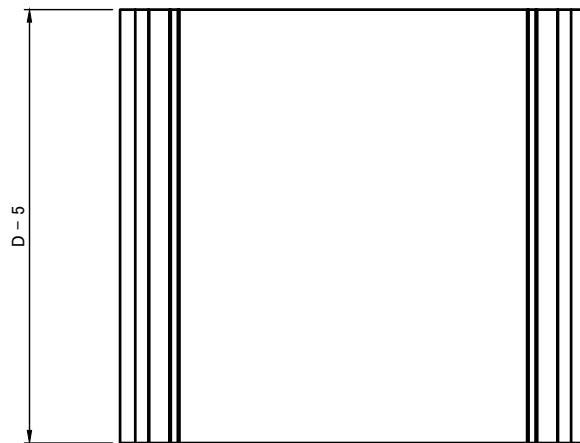
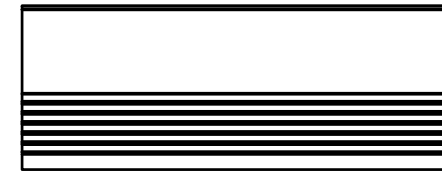
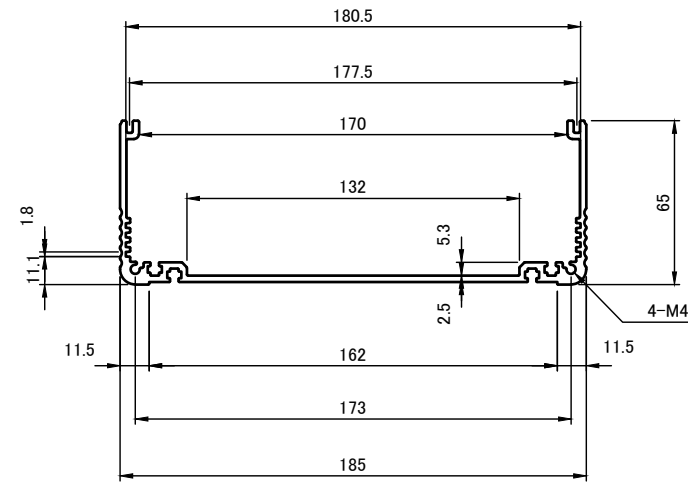
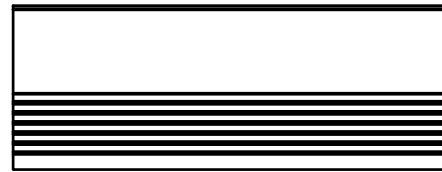
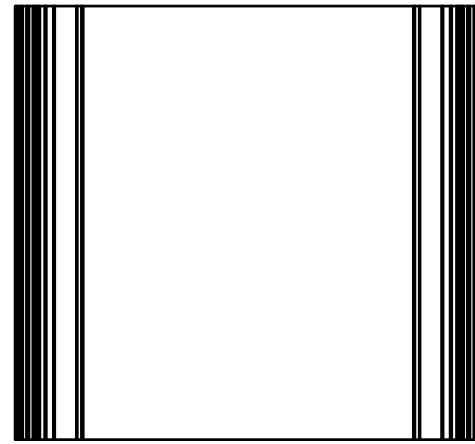

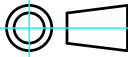
 株式会社タカチ電機工業 TAKACHI ELECTRONICS ENCLOSURE CO., LTD.			品名/Title 下カバー BOTTOM FRAME	 尺度/Scale 1:3
承認/Approved	検図/Checked	製図/Created	型番/Product number W185-H80	
中根	岡本	大江	作成日/Date 2022/10/14	4 / 5

パネル / Panel

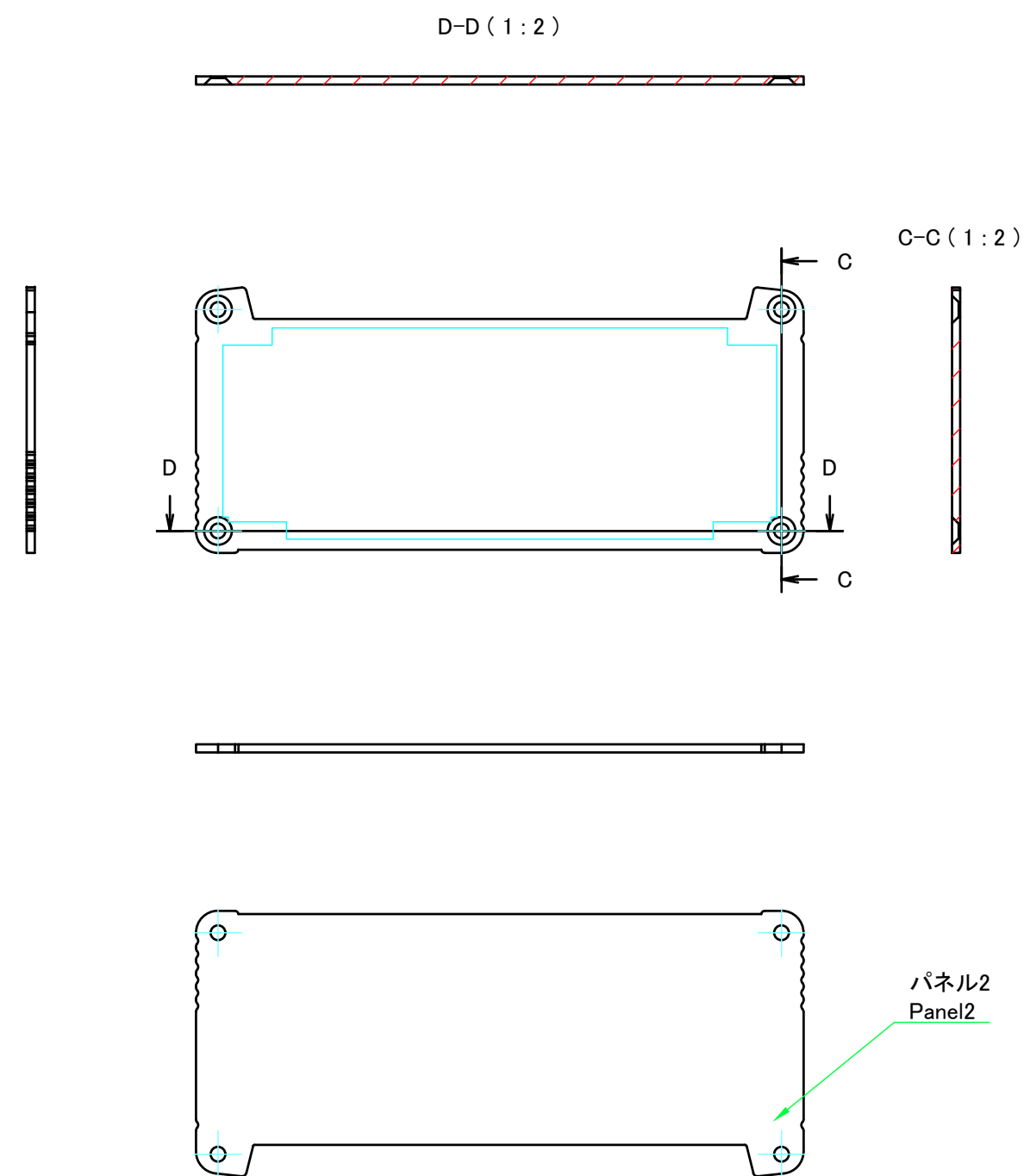
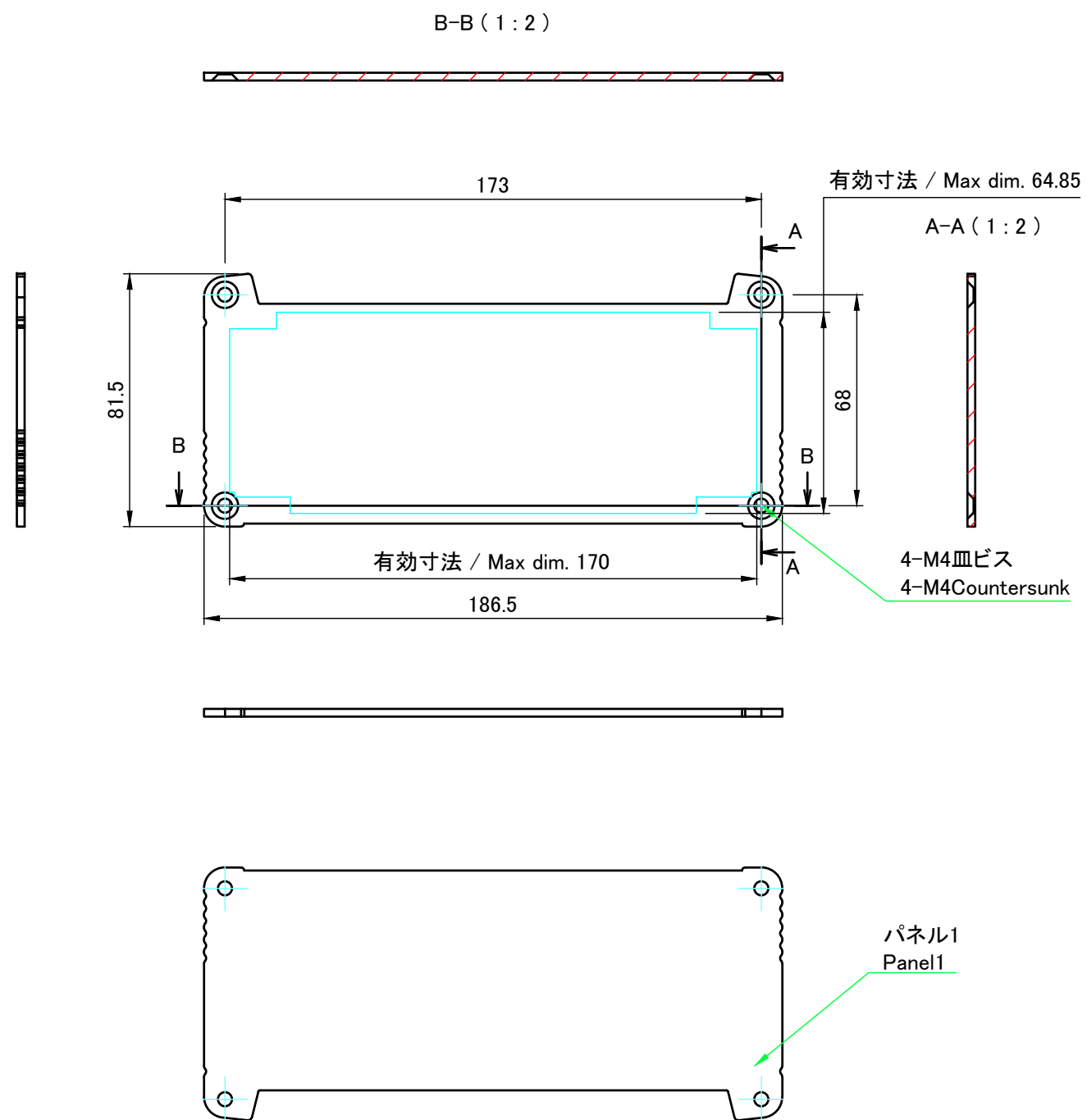

株式会社タカチ電機工業 <small>TAKACHI ELECTRONICS ENCLOSURE CO., LTD.</small>			品名/Title アルミパネル PANEL	尺度/Scale 1:2
承認/Approved	検図/Checked	製図/Created	型番/Product number W186.5-H81.5	
中根	大江	岡本	作成日/Date 2022/10/14	5 / 5