

構成内容 / Components				
No.	名称 / Part name	数量 / Pcs	材質 / Material	色・表面処理 / Color・Finish
1	パネル / End panel	2	アルミ板 / Aluminium A1050P	ブラック, シルバー・アルマイト / Black, Silver・anodized
2	上カバー / Top cover	1	アルミ押出材 / Extruded aluminium A6063S-T5	ブラック, シルバー・アルマイト & クリア塗装 / Black, Silver・anodized & clear coated
3	下カバー / Bottom cover	1	アルミ押出材 / Extruded aluminium A6063S-T5	ブラック, シルバー・アルマイト & クリア塗装 / Black, Silver・anodized & clear coated
4	取付ビス(六角穴付皿 M5×10) / Screw	8	ステンレス / Stainless steel	無処理 / Unfinished
5	ゴム足 / Rubber feet	4	合成ゴム / Rubber	ブラック / Black

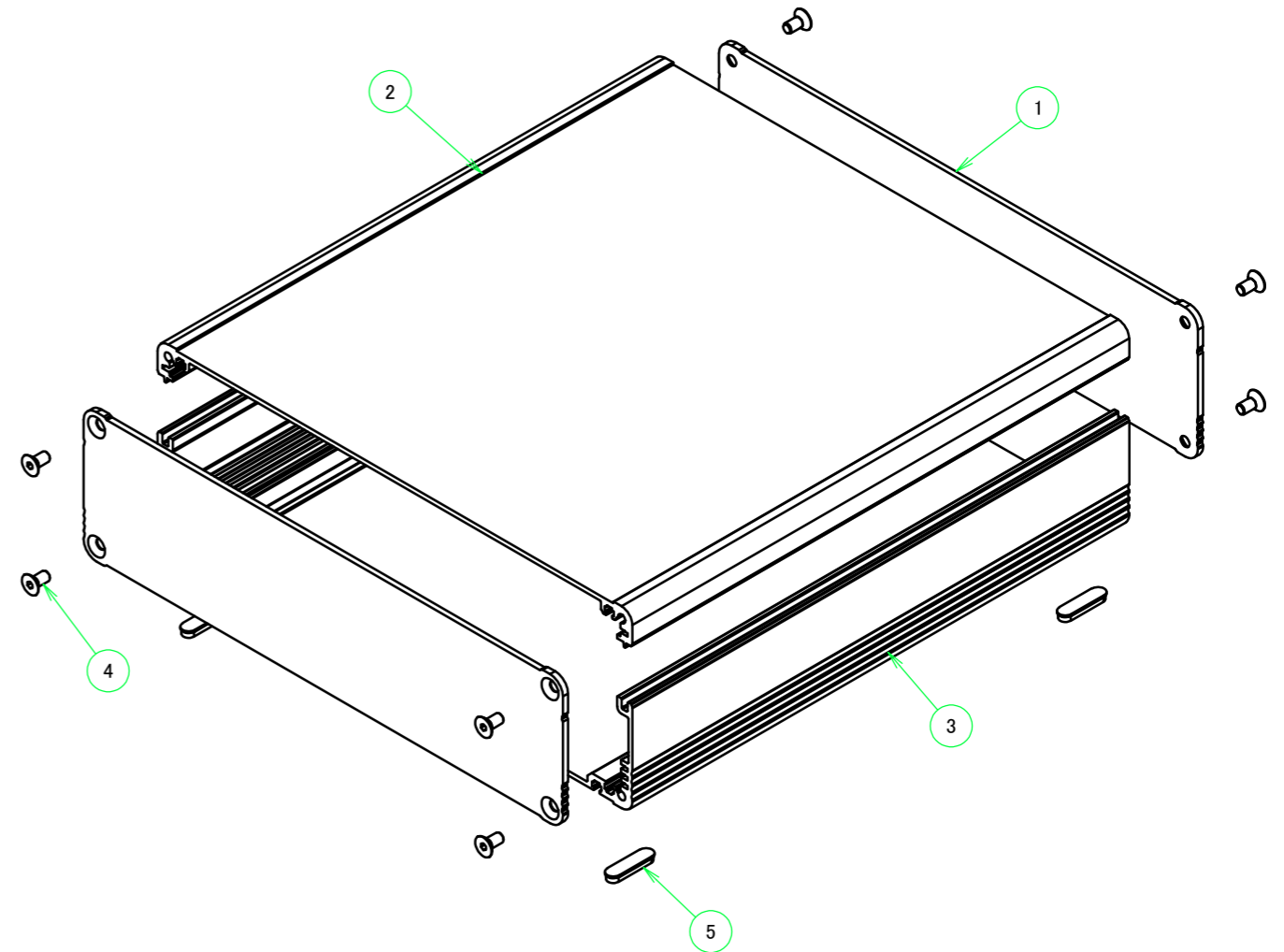

※ゴム足は任意の場所に貼り付けできます。

※Adhesive rubber feet included.

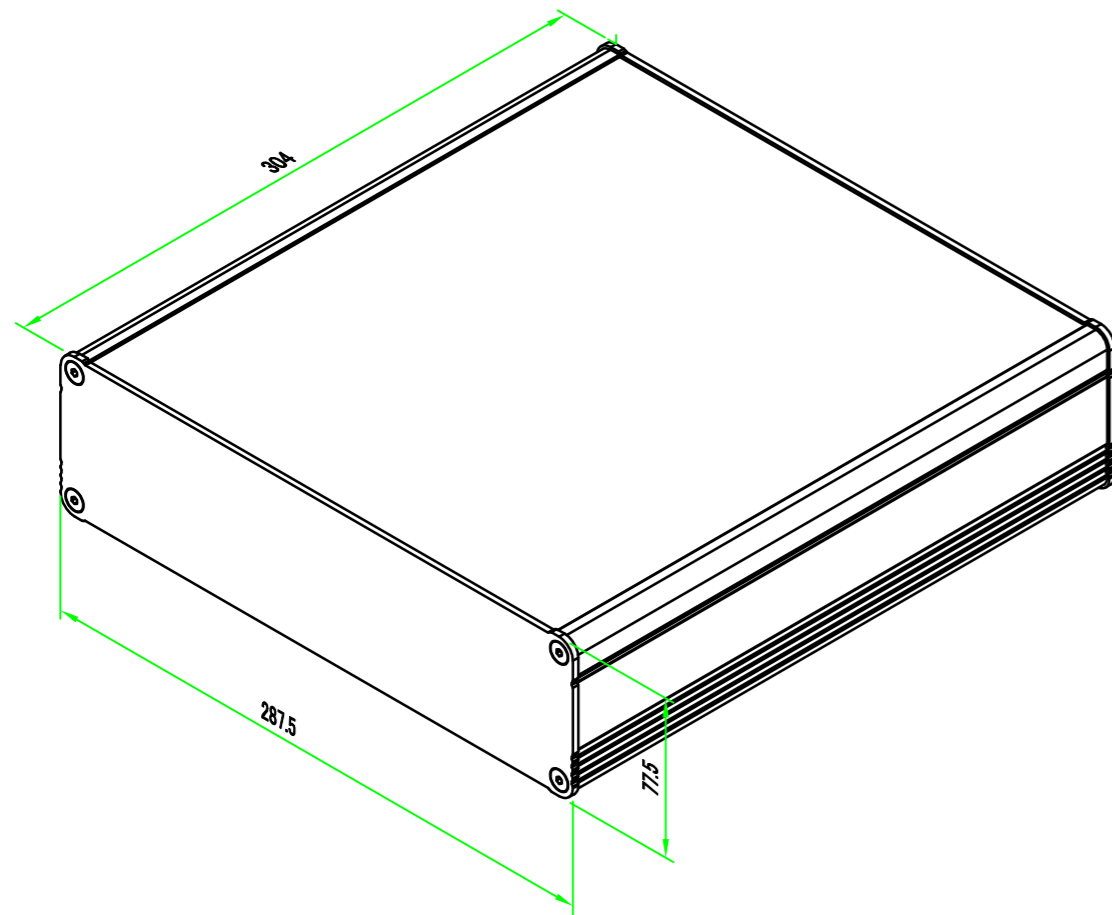

本図面および付帯する部品図の著作権は株式会社タカチ電機工業に帰属します。 / Copyright (C) TAKACHI ELECTRONICS ENCLOSURE CO., LTD. All Rights Reserved.

色仕様(型番末尾口) / Color type		
記号 / Code	上下カバー / Cover	パネル / Panel
SS	シルバー / Silver	シルバー / Silver
SB	シルバー / Silver	ブラック / Black
BS	ブラック / Black	シルバー / Silver
BB	ブラック / Black	ブラック / Black

 <b>株式会社タカチ電機工業</b> TAKACHI ELECTRONICS ENCLOSURE CO., LTD.			品名 / Title <b>アルミ押出材ケース</b> EXTRUDED ALUMINIUM CASE	 尺度 / Scale 1 : 3
承認 / Approved 中根	検図 / Checked 大江	製図 / Created 岡本	型番 / Product number <b>EX29-8-30□□</b> 作成日 / Date 2022/11/22	

ゴム足

Rubber feet

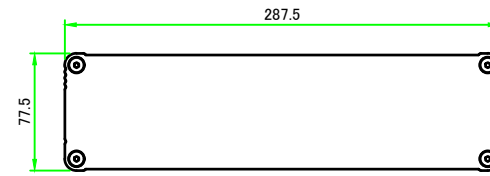
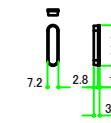

B-B (1:5)

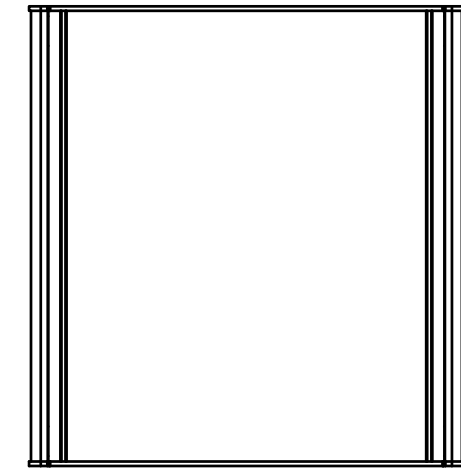
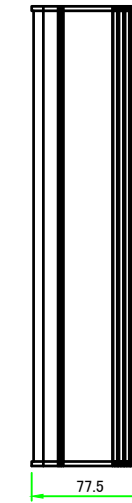
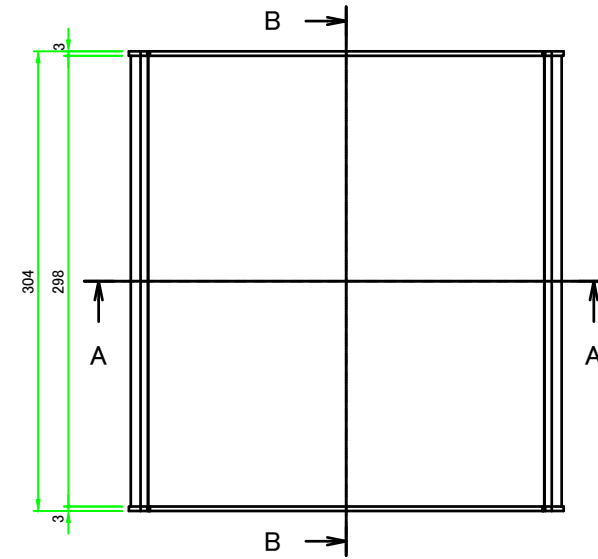
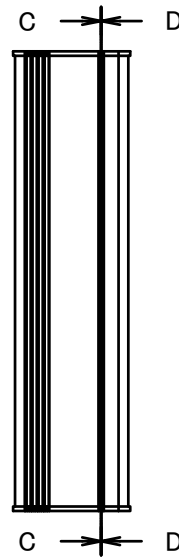
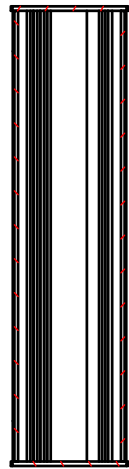

C-C (1:5)

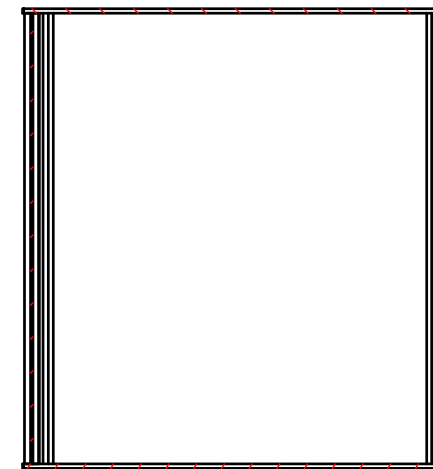

D-D (1:5)

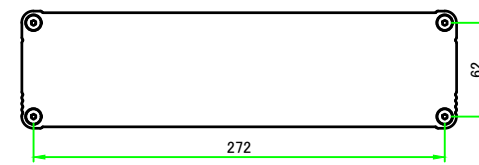
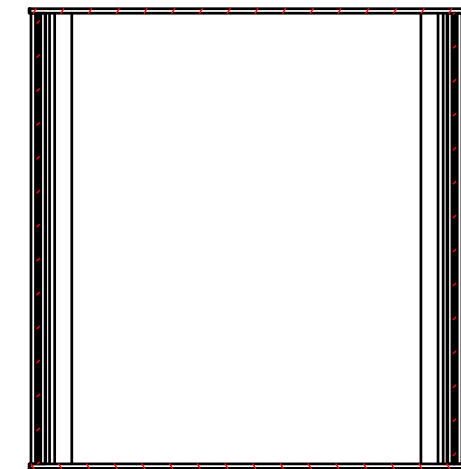

A-A (1:5)

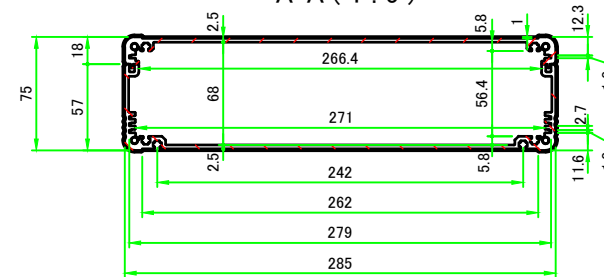

株式会社タカチ電機工業 TAKACHI ELECTRONICS ENCLOSURE CO., LTD.			品名/Title アルミ押出材ケース EXTRUDED ALUMINIUM CASE	尺度/Scale 1:5
承認/Approved 中根	検図/Checked 大江	製図/Created 岡本	型番/Product number EX29-8-30□□	
			作成日/Date 2022/04/01	2 / 5

上カバー / Top cover

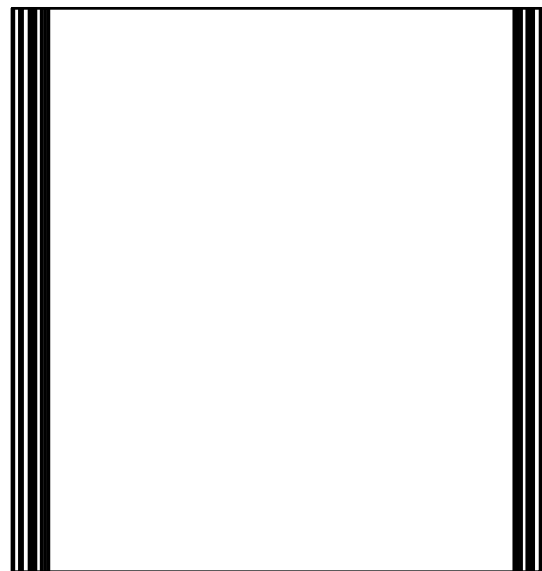
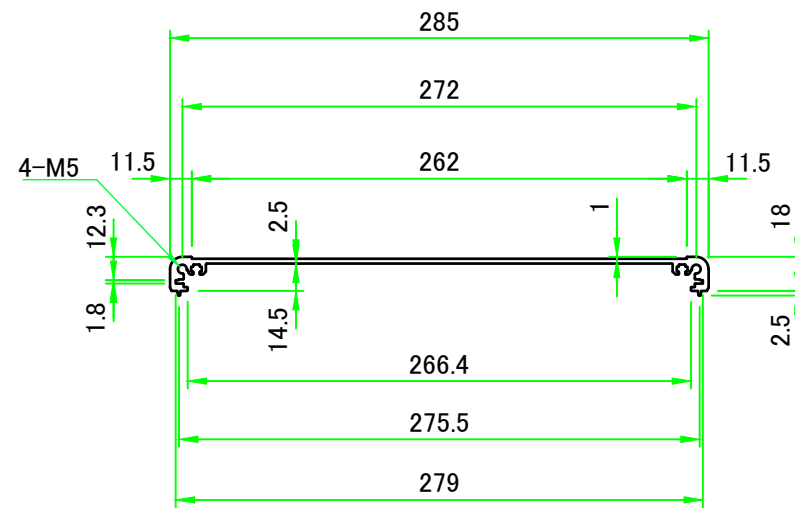
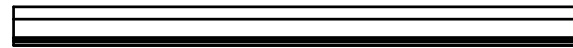
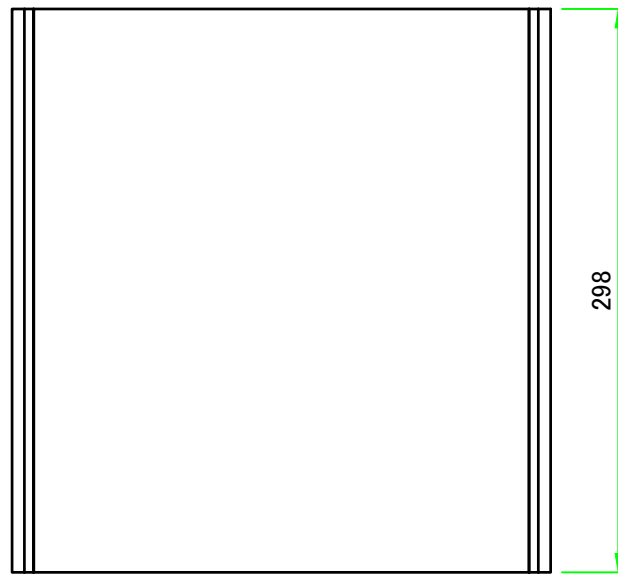

 株式会社タカチ電機工業 TAKACHI ELECTRONICS ENCLOSURE CO., LTD.			品名/Title 上カバー TOP COVER	 尺度/Scale 1: 4
承認/Approved 中根	検図/Checked 岡本	製図/Created 大江	型番/Product number W285-D298	
			作成日/Date 2021/07/13	3 / 5

下カバー / Bottom cover

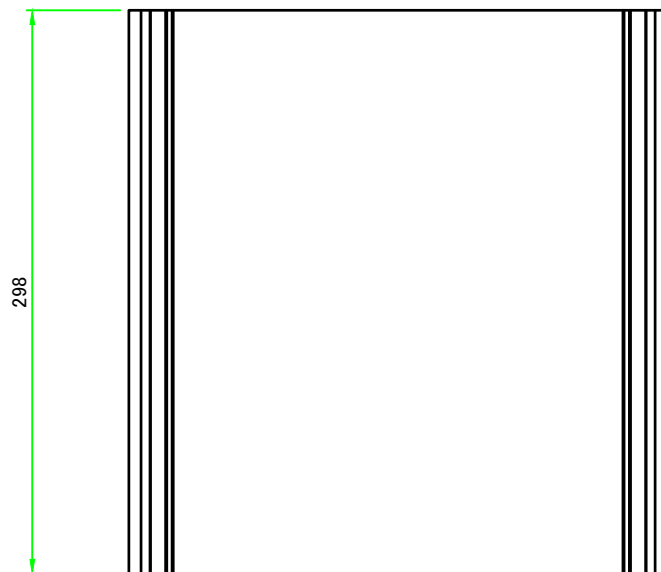
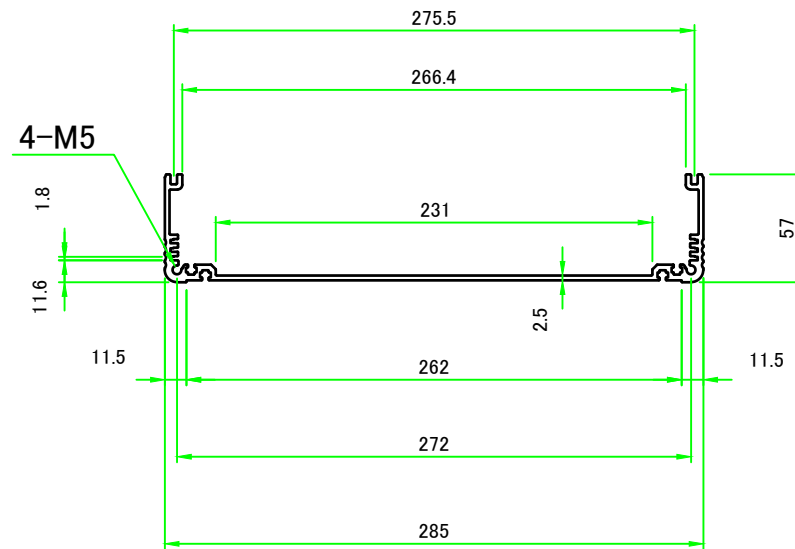
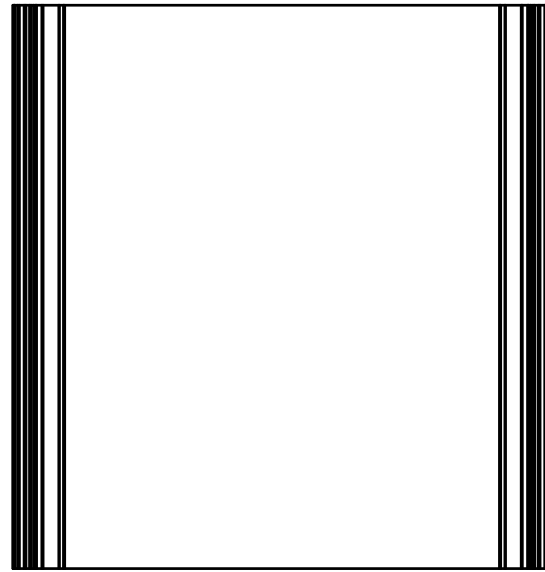

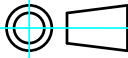
 株式会社タカチ電機工業 TAKACHI ELECTRONICS ENCLOSURE CO., LTD.			品名/Title 下カバー BOTTOM COVER	 尺度/Scale 1:4
承認/Approved	検図/Checked	製図/Created	型番/Product number W285-H75-D298	
中根	岡本	大江	作成日/Date 2021/07/08	4 / 5

# パネル / End panel

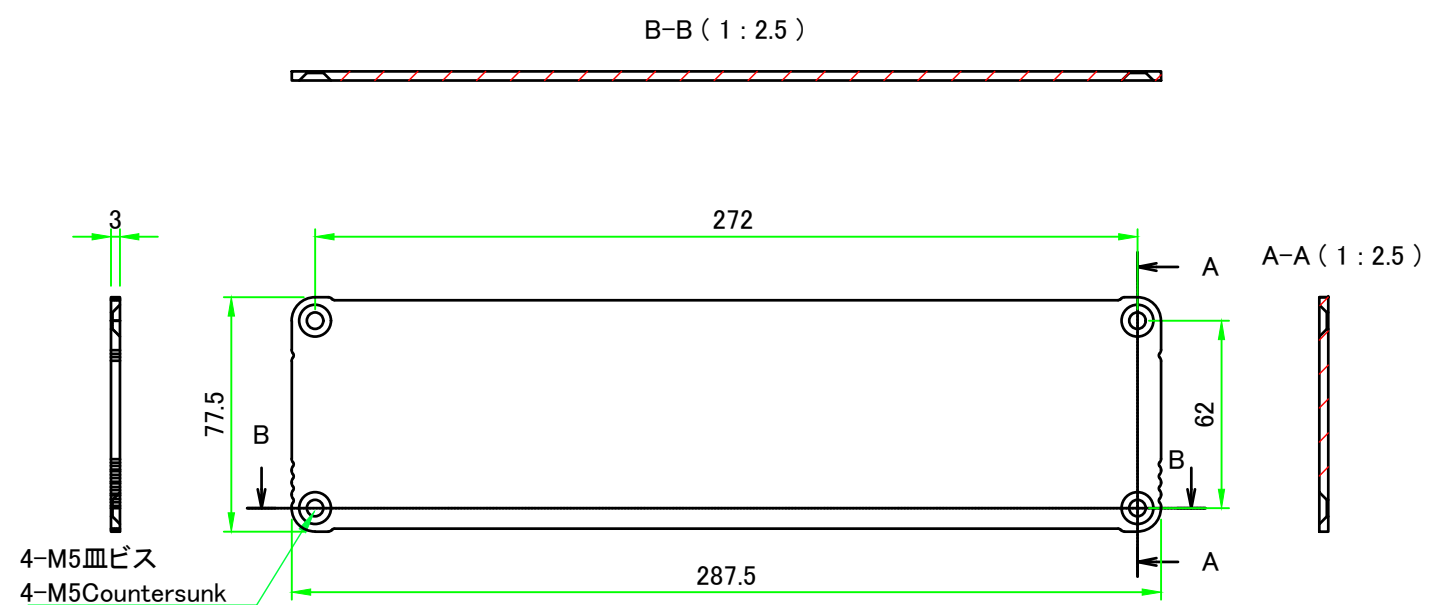

表面 / Outside

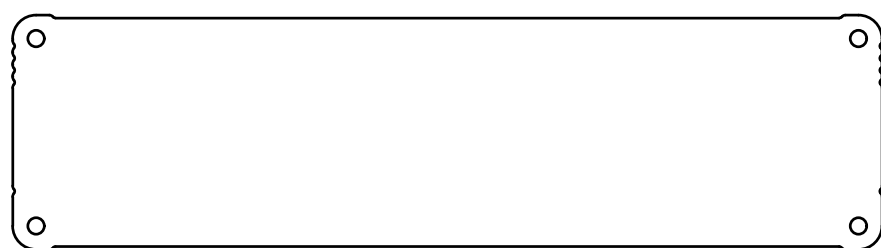

裏面 / Inside

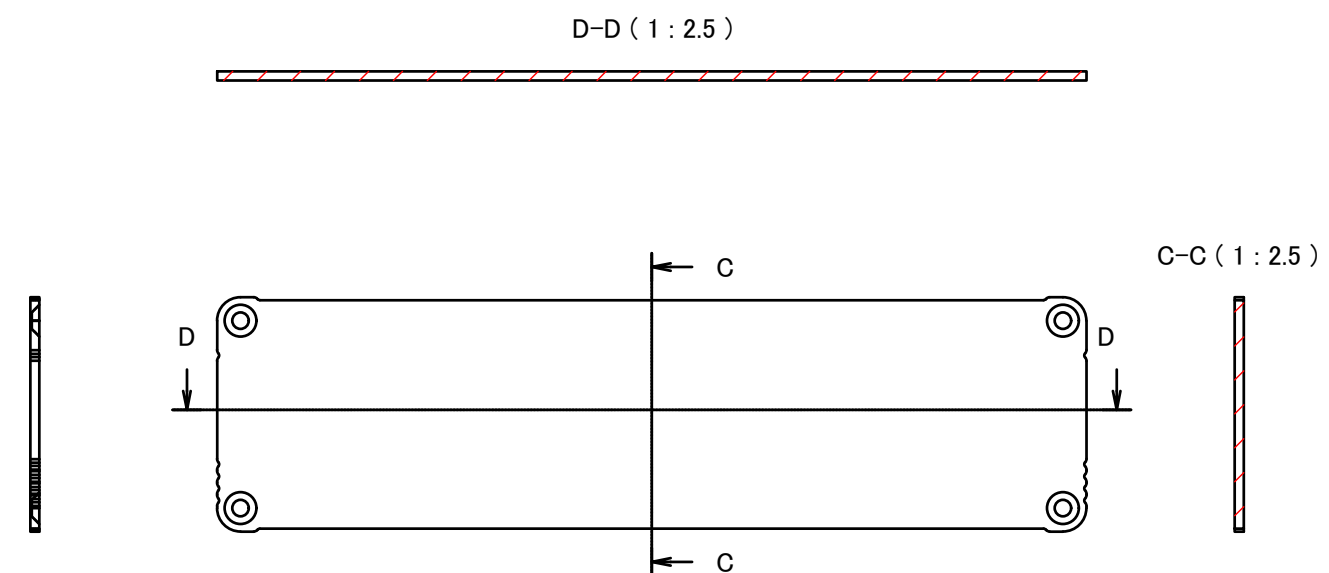

表面 / Outside

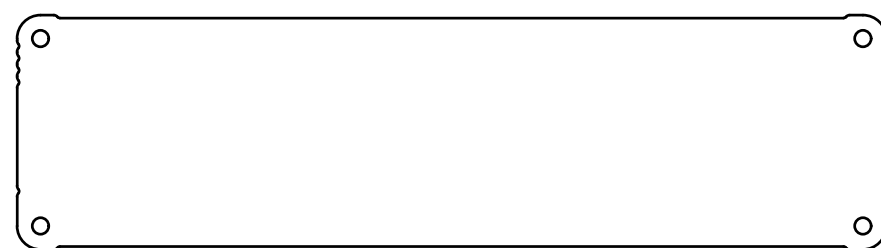

裏面 / Inside

<b>株式会社タカチ電機工業</b> <small>TAKACHI ELECTRONICS ENCLOSURE CO., LTD.</small>			品名/Title アルミ押出材ケース EXTRUDED ALUMINIUM CASE	尺度/Scale 1:2.5
承認/Approved	検図/Checked	製図/Created	型番/Product number EX29-8-〇□□	
中根	大江	岡本	作成日/Date 2022/04/01	5 / 5